

Panasonic

Panasonic

JQ1-18V-F

Part Number:

JQ1-18V-F

Producent / marka:

Panasonic

Opis produktu

JQ RELAY 1 FORM C 18V

Arkusze danych:

 JQ1-18V-F.pdf

Status RoHS

 Bezołowiowa / zgodna z RoHS

Statek z

Hongkong

Sposób wysyłki

DHL/Fedex/TNT/UPS/EMS

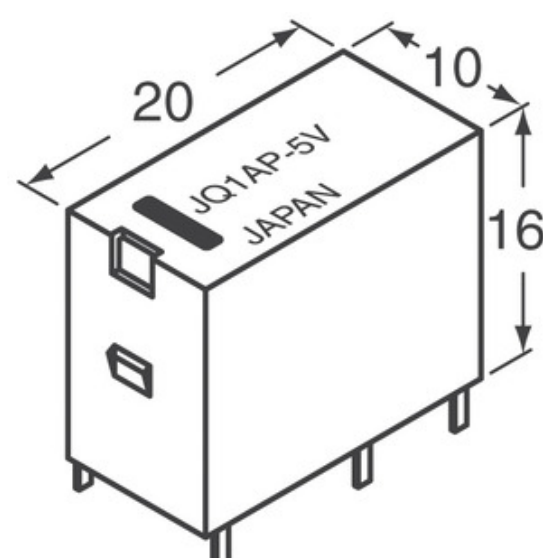

Obraz może być reprezentacją. Zobacz specyfikację dla szczegółów produktu.

PROŚBA O OFERTĘ













Specyfikacje JQ1-18V-F

PART NUMBER	JQ1-18V-F
PRODUCENT	Panasonic
OPIS	JQ RELAY 1 FORM C 18V
STAN OŁOWIU / STATUS ROHS	Bezołowiowa / zgodna z RoHS
ARKUSZ DANYCH	 JQ1-18V-F.pdf
SERIA	*
POZIOM CZUŁOŚCI NA WILGOĆ (MSL)	1 (Unlimited)
STANDARDOWY CZAS OCZEKIWANIA PRODUCENTA	12 Weeks
STATUS BEZOŁOWIOWY / STATUS ROHS	Lead free / RoHS Compliant
SZCZEGÓŁOWY OPIS	Relay Coil

Powiązane tagi

Panasonic JQ1-18V-F	Dystrybutor JQ1-18V-F	Dostawca JQ1-18V-F
Cena JQ1-18V-F	Zdjęcia JQ1-18V-F	Obraz JQ1-18V-F
Arkusz danych JQ1-18V-F PDF	JQ1-18V-F Pobierz arkusz danych	Arkusz danych JQ1-18V-F
Zdjęcie JQ1-18V-F	Kup JQ1-18V-F	Kup Panasonic JQ1-18V-F
Panasonic JQ1-18V-F	Panasonic Dostawca	Dystrybutor Panasonic
Panasonic JQ1-18V-F	Panasonic - Consumer Division JQ1-18V-F	Panasonic - Consumer Electronics Corp. JQ1-18V-F
Panasonic Battery Group JQ1-18V-F	Panasonic Electric Works - ACSD JQ1-18V-F	Panasonic Electronic Components - Semiconductor Pr JQ1-18V-F
Panasonic - ATG JQ1-18V-F	Panasonic - BSG JQ1-18V-F	Panasonic - DTG JQ1-18V-F
Panasonic Electric Works JQ1-18V-F	Panasonic Electronic Components JQ1-18V-F	Panasonic Industrial Automation Sales JQ1-18V-F
Panasonic Semiconductor JQ1-18V-F		

Produkty powiązane

 <p>JQ1-6V-F Producenci: Panasonic Opis: RELAY GENERAL PURPOSE SPDT 5A 6V Na stanie: Out stock RFQ</p>	 <p>JQ1-5V Producenci: Panasonic Opis: RELAY GENERAL PURPOSE SPDT 5A 5V Na stanie: Out stock RFQ</p>
 <p>JQ1-3V Producenci: Panasonic Opis: RELAY GENERAL PURPOSE SPDT 5A 3V Na stanie: Out stock RFQ</p>	 <p>JQ1-24V Producenci: Panasonic Opis: RELAY GEN PURPOSE SPDT 5A 24V Na stanie: Out stock RFQ</p>
 <p>JQ1-5V-F Producenci: Panasonic Opis: RELAY GENERAL PURPOSE SPDT 5A 5V Na stanie: Out stock RFQ</p>	 <p>JQ1-48V Producenci: Panasonic Opis: RELAY GEN PURPOSE SPDT 5A 48V Na stanie: Out stock RFQ</p>
 <p>JQ1-48V-F Producenci: Panasonic Opis: RELAY GEN PURPOSE SPDT 5A 48V Na stanie: 100 pcs RFQ</p>	 <p>JQ1-6V Producenci: Panasonic Opis: RELAY GENERAL PURPOSE SPDT 5A 6V Na stanie: Out stock RFQ</p>
 <p>JQ1-12V Producenci: Panasonic Opis: RELAY GEN PURPOSE SPDT 5A 12V Na stanie: Out stock RFQ</p>	 <p>JQ1-18V Producenci: Panasonic Opis: RELAY GEN PURPOSE SPDT 5A 18V Na stanie: Out stock RFQ</p>
 <p>JQ1-24V-F Producenci: Panasonic Opis: RELAY GEN PURPOSE SPDT 5A 24V Na stanie: Out stock RFQ</p>	 <p>JQ1-12V-F Producenci: Panasonic Opis: RELAY GEN PURPOSE SPDT 5A 12V Na stanie: Out stock RFQ</p>