

THIS DOCUMENT IS THE PROPERTY OF
KEYSTONE ELECTRONICS CORP. AND
SHALL NOT BE REPRODUCED, DISTRIBUTED
OR USED AS A BASIS FOR MANUFACTURE
WITHOUT PRIOR WRITTEN PERMISSION
FROM KEYSTONE ELECTRONICS CORP.

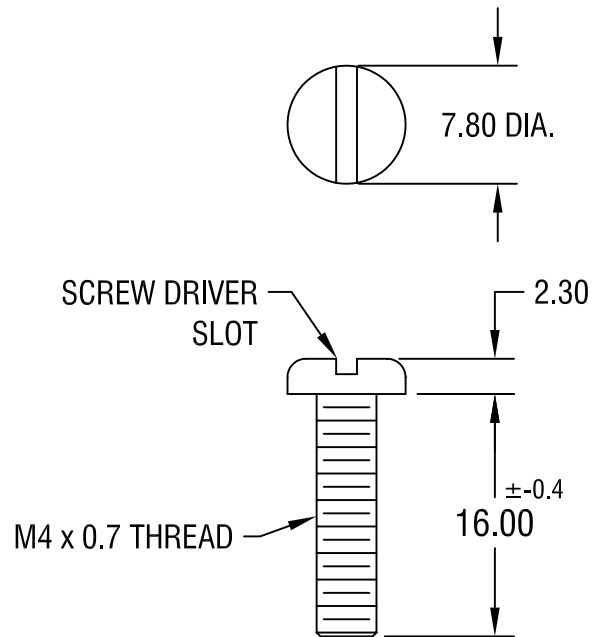

NOTE:

1. ALL DIMENSIONS ARE IN MILLIMETERS

KEYSTONE ELECTRONICS CORP.			
ASTORIA, N.Y. 11105-2017			
PART NAME		M4 PAN HEAD SCREW	
MATERIAL		STEEL	
FINISH		DRN BY	DATE
ZINC PLATE CLEAR CHROMATE		BOONE	10.16.06
		APP'D	SCALE
		LN	2X
TOLERANCES		INCH	[MM]
DECIMAL		±	[± 0.25]
ANGULAR		± 1°	
UNLESS OTHERWISE SPECIFIED		CODE	DWG NO.
		C/M	29326

DATE	DESCRIPTION	REV.