

LOC H	DIST —	REVISIONS			
P	LTR	DESCRIPTION	DATE	DWN	APVD
	C	ECR-05-006211	13JUL05	CJF	JB

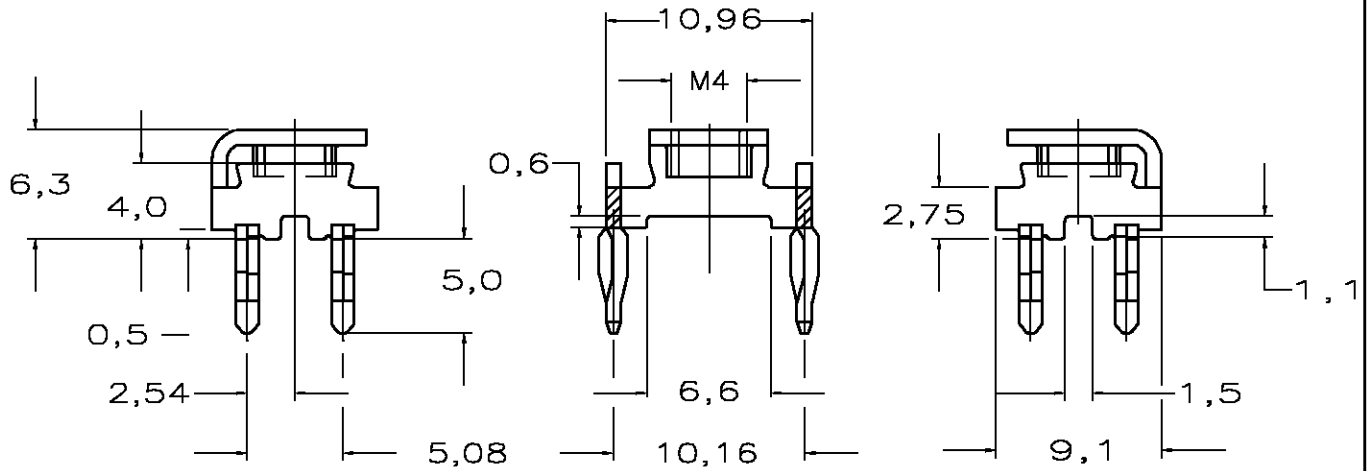

NOTES :

- 1 PLATING: Sn PLATE TO ASTM B 545 AND NI UNDERCOAT TO ASTM B 571 ALL OVER
- 2 MATERIAL THICKNESS 0,8 mm .

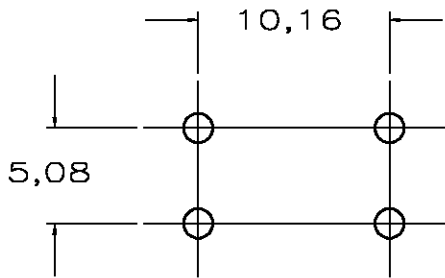

RECOMMENDED BOARD LAYOUT

THIS DRAWING IS UNPUBLISHED.

ALL RIGHTS RESERVED.

COPYRIGHT © BY TYCO ELECTRONICS CORPORATION.

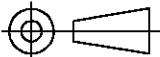
DIMENSIONS: MM		DWN S.MEEUWSEN 13FEB90	MATERIAL —	PHOSPHORBRONZE	216906-1
TOLERANCES UNLESS OTHERWISE SPECIFIED:		CHK R.V.LOKVEN 03APR90	FINISH —	MATERIAL	PART NUMBER
0 PLC ± -		APVD L.V. SOEST 03APR90	 Tyco Electronics Corporation s-Hertogenbosch, Nederland,		
1 PLC ± -		PRODUCT SPEC 108-19059			
2 PLC ± -		APPLICATION SPEC —	NAME POWER TERMINAL WITH ACTION PIN (1,6-3,2 P.C.BOARD THK'S.)		
3 PLC ± -		WEIGHT —	SIZE A4	CAGE CODE 00779	DRAWING NO C-216906
4 PLC ± -			RESTRICTED TO —		
ANGLES ± -			CUSTOMER DRAWING		
			SCALE 1:1	SHEET 1 OF 1	REV C