

Evaluation Board for the **ADF4351** Fractional-N PLL Frequency Synthesizer

FEATURES

Self-contained board including PLL, VCO, loop filter (35 kHz), 25 MHz TCXO reference, USB interface, and voltage regulators

Accompanying software allows control of synthesizer functions from a PC

Choice of power supply via USB or external feeding

Typical phase noise performance of -104 dBc/Hz @ 3 kHz offset from carrier (1 GHz output frequency)

EVALUATION KIT CONTENTS

EVAL-ADF4351EB1Z board

USB Standard-A to Mini-B cable

CD that includes

- Self-installing software that allows users to control the board and exercise all functions of the device

- Electronic version of the **ADF4351** data sheet

- Electronic version of the UG-435 user guide

ADDITIONAL EQUIPMENT

PC running Windows XP or more recent version

Spectrum analyzer

Oscilloscope (optional)

DOCUMENTS NEEDED

ADF4351 data sheet

REQUIRED SOFTWARE

Analog Devices ADF435xPLL software (Version 4 or higher)

ADIsimPLL™

GENERAL DESCRIPTION

This board is designed to allow the user to evaluate the performance of the **ADF4351** frequency synthesizer for phase-locked loops (PLLs). Figure 1 shows the board, which contains the **ADF4351** integrated synthesizer and VCO, SMA connectors for the output signal, power supplies, a reference oscillator, and an USB connector. There is also a loop filter (35 kHz) on board. The evaluation board is set up for a 25 MHz PFD comparison frequency. An on-board TCXO provides the 25 MHz reference frequency.

The package also contains Windows® software (XP or later) to allow easy programming of the synthesizer.

EVALUATION BOARD

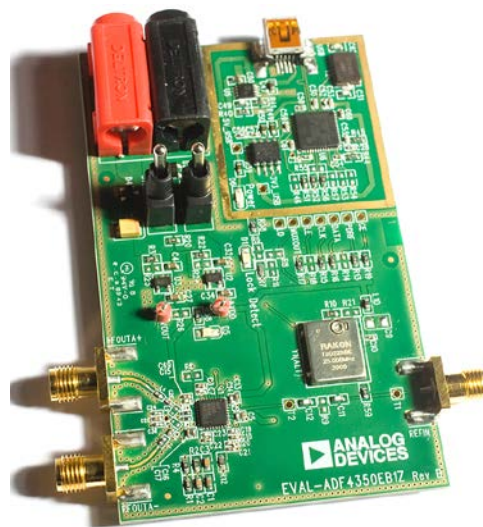

Figure 1. EVAL-ADF4351EB1Z

TABLE OF CONTENTS

Features	1	Input Signals.....	4
Evaluation Kit Contents.....	1	Loop Filter.....	4
Additional Equipment	1	Output Signals	4
Documents Needed.....	1	Evaluation Board Setup Procedure	5
Required Software	1	Software Installation	5
General Description	1	Evaluation Board Software	9
Evaluation Board	1	Evaluation and Test	11
Revision History	2	Evaluation Board Schematics and Artwork.....	12
Quick Start Guide.....	3	Ordering Information.....	17
Evaluation Board Hardware	4	Bill of Materials.....	17
Power Supplies	4		

REVISION HISTORY

6/12—Revision 0: Initial Version

QUICK START GUIDE

Follow these steps to quickly evaluate the [ADF4351](#) device:

1. Install the ADF435x software from the CD.
2. Connect the [EVAL-ADF4351EB1Z](#) to the PC and install the necessary drivers.
3. Follow the hardware driver installation procedure.
4. Ensure that Switches SW1 and SW2 are closed.
5. Run the ADF435x software.
6. Select the USB board connection and the [ADF4351](#) device in the **Select Device and Connection** tab of the software front panel window.
7. Click the **Main Controls** tab. Update all registers.
8. Connect the spectrum analyzer to J2.
9. Measure the results.

EVALUATION BOARD HARDWARE

The [EVAL-ADF4351EB1Z](#) schematics are shown in Figure 22 to Figure 24.

POWER SUPPLIES

The [EVAL-ADF4351EB1Z](#) can be powered either from the USB port or via dc power connectors (4 mm banana connectors). When feeding via banana connectors, 3.75 V to 5.5 V is a suitable feeding voltage. The power supply circuitry allows the user to use one or two separate LDOs to feed the [ADF4351](#) (using fewer LDOs increases the risk of spur contaminated dc feeds). Consult the board schematic in Figure 22, Figure 23, and Figure 24 to determine a suitable setting.

An LED, D6, indicates when USB power is available, and another LED, D5, indicates when the [ADF4351](#) is powered. Switch S1 is used to power the [ADF4351](#) from the external dc connectors USB port and Switch S2 to power from the USB port.

In case the USB processor or clock causes spurs on the RF output signal, the user may feed the evaluation board via the dc connectors and unplug the USB cable, thereby removing power from the USB interface circuitry. There is also a grounded frame surrounding the USB interface circuitry to allow mounting of a shielding box.

INPUT SIGNALS

The 25 MHz TCXO from Rakon provides the necessary reference signal. An external REFIN may be used if desired. In this case, disable the on-board TCXO by removing L10 and R59. R9 can be populated with 50 Ω to adjust impedance matching of the evaluation board to the external reference source.

LOOP FILTER

The loop filter schematic is included in the board schematic on Figure 22. The loop filter component placements are clarified in Figure 2.

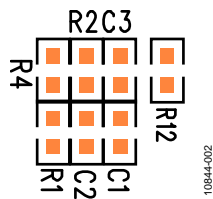

Figure 2. Loop Filter Placement

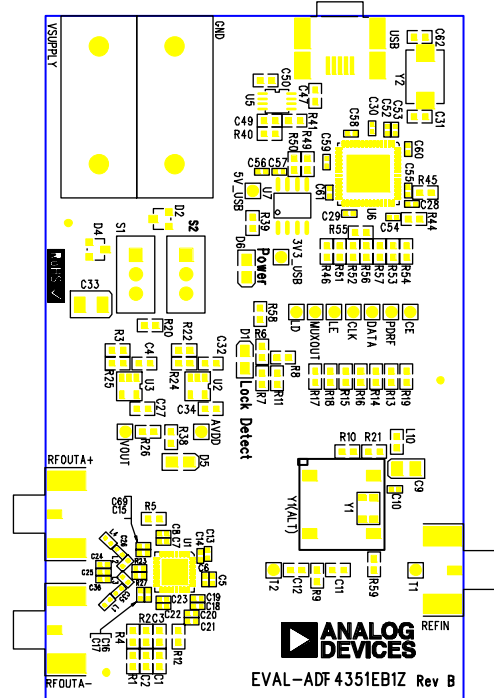

Figure 3. Evaluation Board Silkscreen

OUTPUT SIGNALS

The [EVAL-ADF4351EB1Z](#) has two SMA output connectors (differential outputs). The device is quite sensitive to impedance unbalance. If only one port of a differential pair is used, terminate the other with a 50 Ω load.

The board contains 7.5 nH shunt inductors on the RF output stages, which is optimum for a frequency range of 1 GHz to 4.4 GHz. Lower frequencies than this require larger output stage inductors, or a 50 Ω resistor to V_{DD}, which provides lower output power, but wider frequency bandwidth than the inductors. Consult the [ADF4351](#) data sheet for more information.

The MUXOUT signal can be monitored at the test point labeled MUXOUT.

EVALUATION BOARD SETUP PROCEDURE

SOFTWARE INSTALLATION

The control software and USB drivers for EVAL-ADF4351EB1Z are on the CD, which accompanies the board. If the user runs **ADF435x_Setup.msi**, then the install wizard guides the user through the install process. Simply follow the on-screen instructions. The software and USB drivers will be installed in the default directory called **C:\Program Files\Analog Devices\ADF435x**. The software requires Microsoft's .NET framework version 3.5 or later to be installed on your machine. The installer will automatically download the framework from the Microsoft website if you do not have this installed. If you do not have an internet connection or a slow connection on the PC, then you can install the .NET framework directly from the CD. Do this by double-clicking **dotnetfx35.exe**. Once installed, run the **ADF435x_Setup.msi** again. Note that to install the **dotnetfx35.exe**, you need to have Windows Installer 3.1 or later installed.

1. Install the Analog Devices ADF435x PLL software by double-clicking **ADF435x_Setup.msi**.
If you are using Windows XP, follow the instructions in the Windows XP Software Installation Guide section (see Figure 4 to Figure 8).
If you are using Windows Vista or Windows 7, follow the instructions in the Windows Vista/7 Software Installation Guide section (see Figure 9 to Figure 13).
Note that the software requires Microsoft Windows Installer and Microsoft .NET Framework 3.5 (or higher). The installer connects to the Internet and downloads Microsoft .NET Framework automatically. Alternatively, before running **ADF435x_Setup.msi**, both the installer and .NET Framework can be installed from the CD provided.
2. Connect your SDP board (black) or USB adapter board (green) by USB. If you are using an SDP board, the drivers install automatically, and you are ready to run the software. If you are using an USB adapter board on Windows XP, follow the steps in the Windows XP Driver Installation Guide section (see Figure 14 to Figure 17).

On Windows Vista or Windows 7, the drivers install automatically.

Windows XP Software Installation Guide

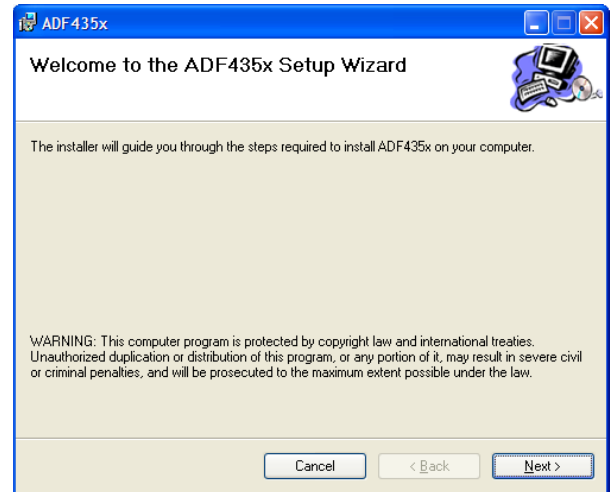

Figure 4. Windows XP ADF435x Software Installation, Setup Wizard

1. Click **Next**.

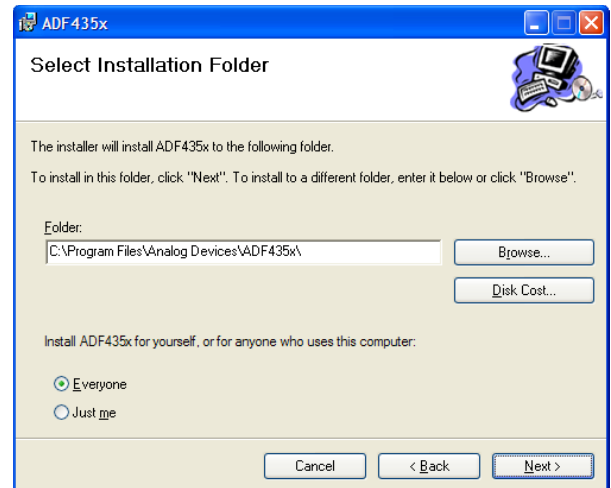

Figure 5. Windows XP ADF435x Software Installation, Select Installation Folder

2. Choose an installation directory and click **Next**.

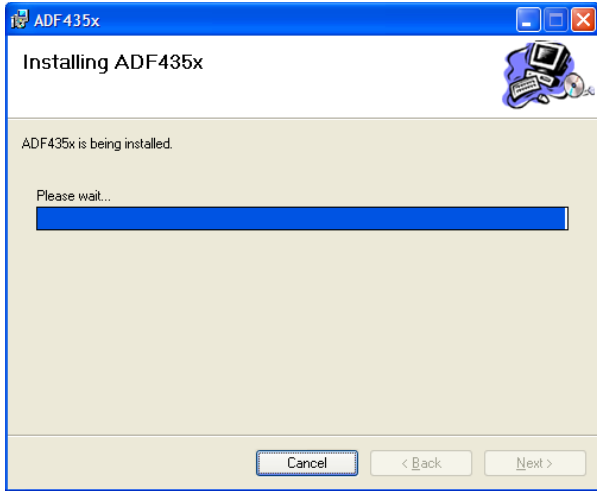

Figure 6. Windows XP ADF435x Software Installation, Confirm Installation

3. Click **Next**.



Figure 7. Windows XP ADF435x Software Installation, Logo Testing

4. Click **Continue Anyway**.

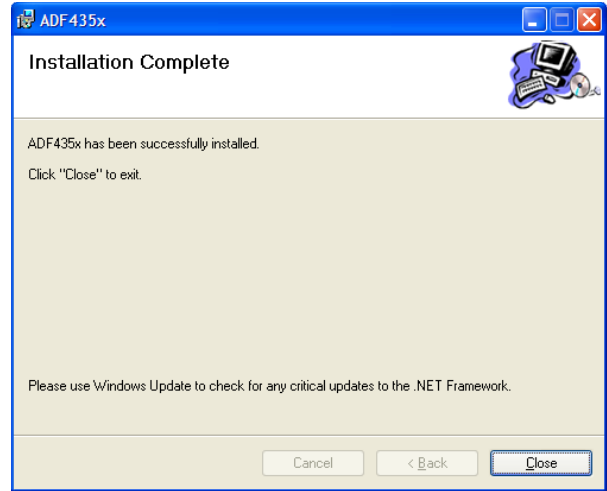

Figure 8. Windows XP ADF435x Software Installation, Installation Complete

5. Click **Close**.

Windows Vista/7 Software Installation Guide

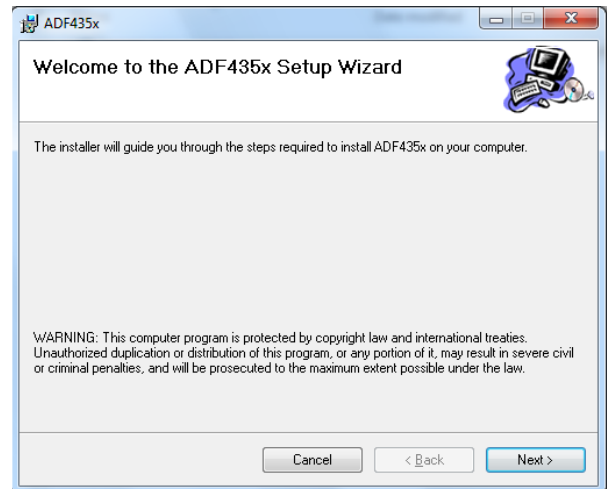

Figure 9. Windows Vista/7 ADF435x Software Installation, Setup Wizard

1. Click **Next**.

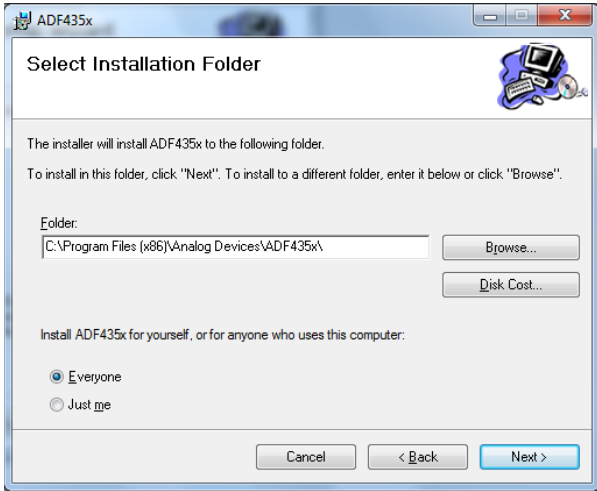

Figure 10. Windows Vista/7 ADF435x Software Installation, Select Installation Folder

2. Choose an installation directory and click **Next**.

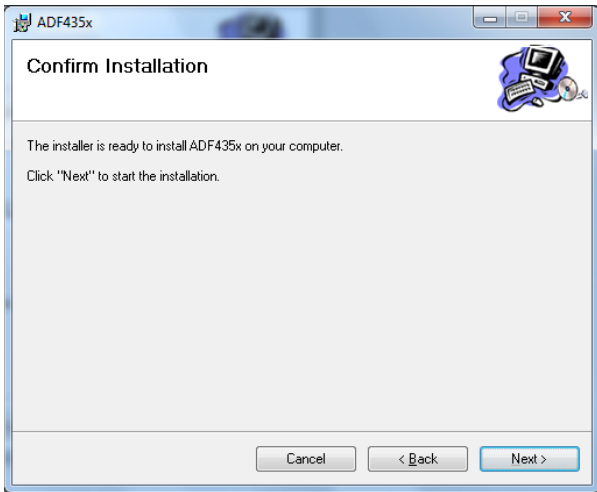

Figure 11. Windows Vista/7 ADF435x Software Installation, Confirm Installation

3. Click **Next**.

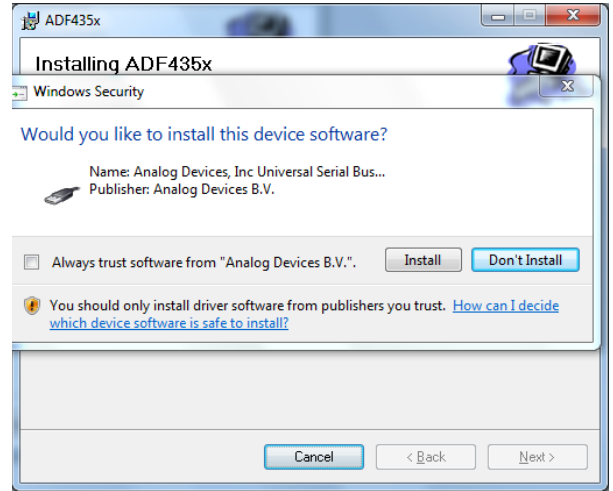

Figure 12. Windows Vista/7 ADF435x Software Installation, Start Installation

4. Click **Install**.

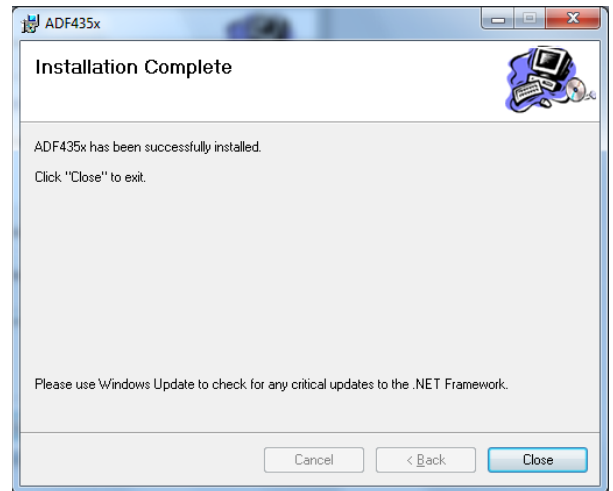

Figure 13. Windows Vista/7 ADF435x Software Installation, Installation Complete

5. Click **Close**.

Windows XP Driver Installation Guide



Figure 14. Windows XP USB Adapter Board Driver Installation, Found New Hardware Wizard

1. Choose **Yes, this time only**, and click **Next**.

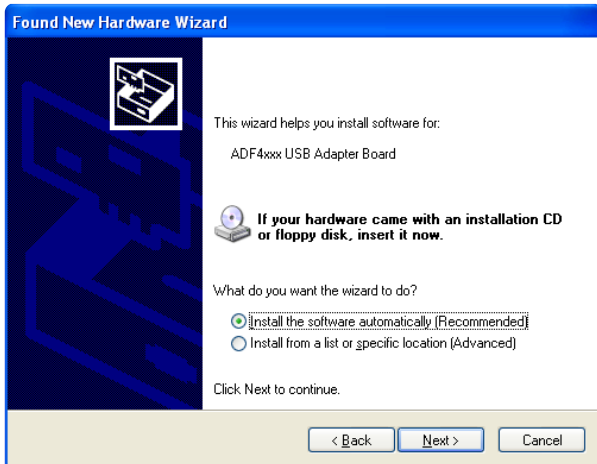

Figure 15. Windows XP USB Adapter Board Driver Installation, Installation Options

2. Click **Next**.

Note that Figure 15 may list **Analog Devices RFG.L Eval Board** instead of **ADF4xxx USB Adapter Board**.

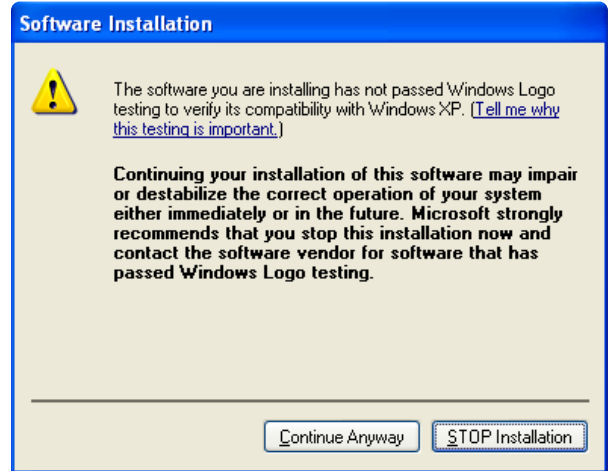

Figure 16. Windows XP USB Adapter Board Driver Installation, Logo Testing

3. Click **Continue Anyway**.

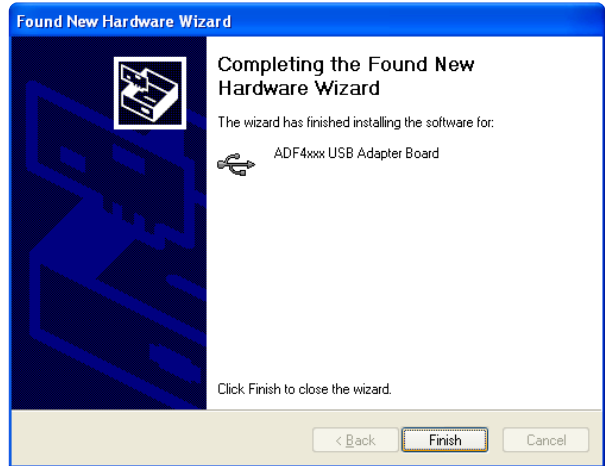

Figure 17. Windows XP USB Adapter Board Driver Installation, Complete Installation

4. Click **Finish**.

EVALUATION BOARD SOFTWARE

The control software for the [EVAL-ADF4351EB1Z](#) accompanies the [EVAL-ADF4351EB1Z](#) on a CD. To install the software, see the Software Installation section.

To run the software, click the **ADI ADF435x** file on the desktop or in the **Start** menu.

On the **Select Device and Connection** tab, choose your device, your connection method, and click **Connect**.

Confirm that **SDP board connected**, **ADF4xxx USB Adapter Board connected**, or **Analog Devices RFG.L Eval Board connected** is displayed at the bottom left of the window. Otherwise, the software has no connection to the evaluation board.

Note that, when connecting the board, it takes about 5 sec to 10 sec for the status label to change.

Under the **File** menu, the current settings can be saved to and loaded from, a text file.

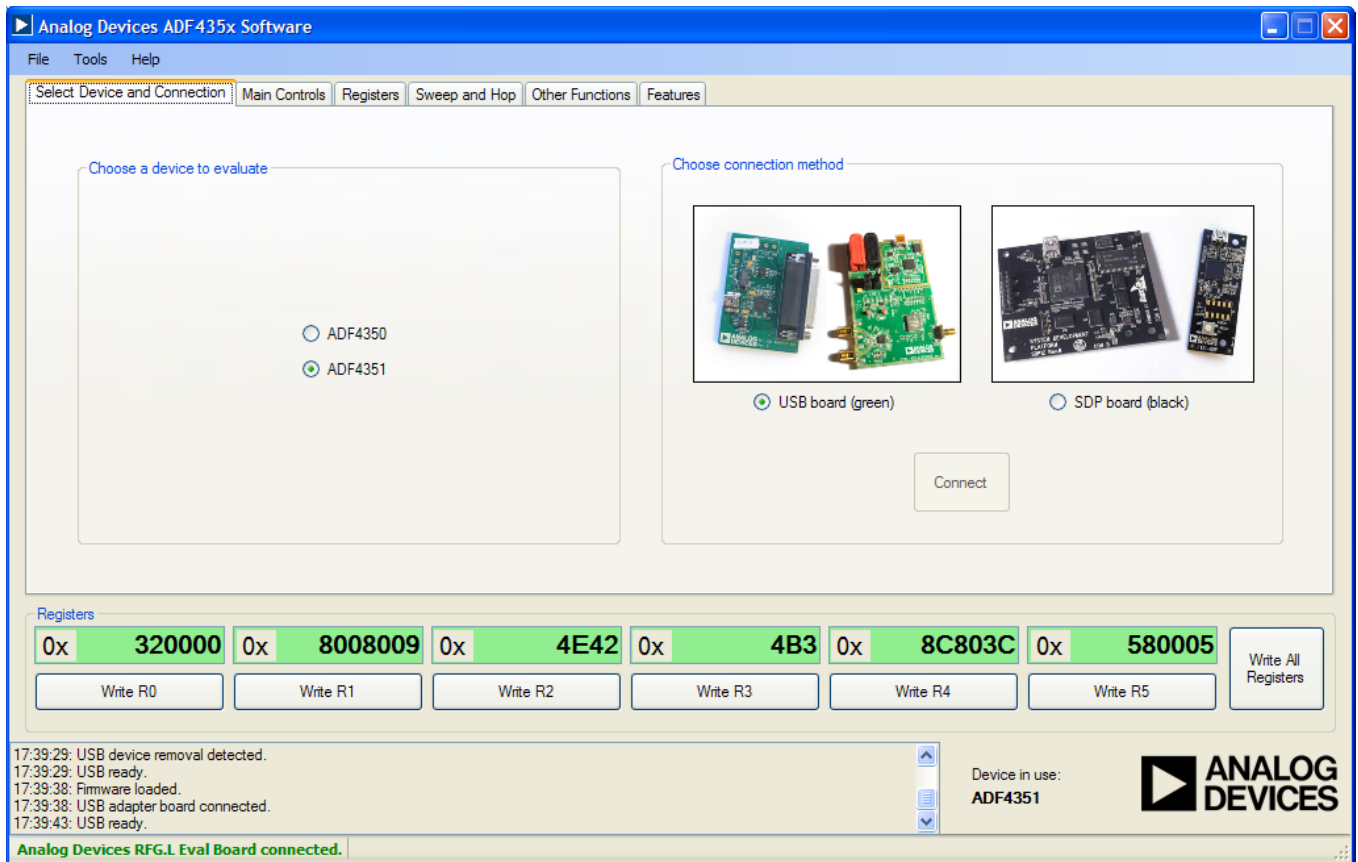

Figure 18. Software Front Panel Display—Select Device and Connection

The **Main Controls** tab controls the PLL settings (see Figure 19).

Use the **Reference Frequency** text box to set the correct reference frequency and the reference frequency divider. The default reference on the software window is 25 MHz.

Use the **RF Settings** section to control the output frequency. You can type the desired output frequency in the **RF Frequency** text box (in megahertz).

In the **Registers** tab, you can manually input the desired value to be written to the registers.

In the **Sweep and Hop** tab, you can make the device sweep a range of frequencies, or hop between two set frequencies.

In the **Registers** section at the bottom of the **Main Controls** tab, the values to be written to each register are displayed. If the background on the text box is green, the value displayed is different from the value actually on the device. Click **Write Rx** (where x = 0 to 5) to write that value to the device.

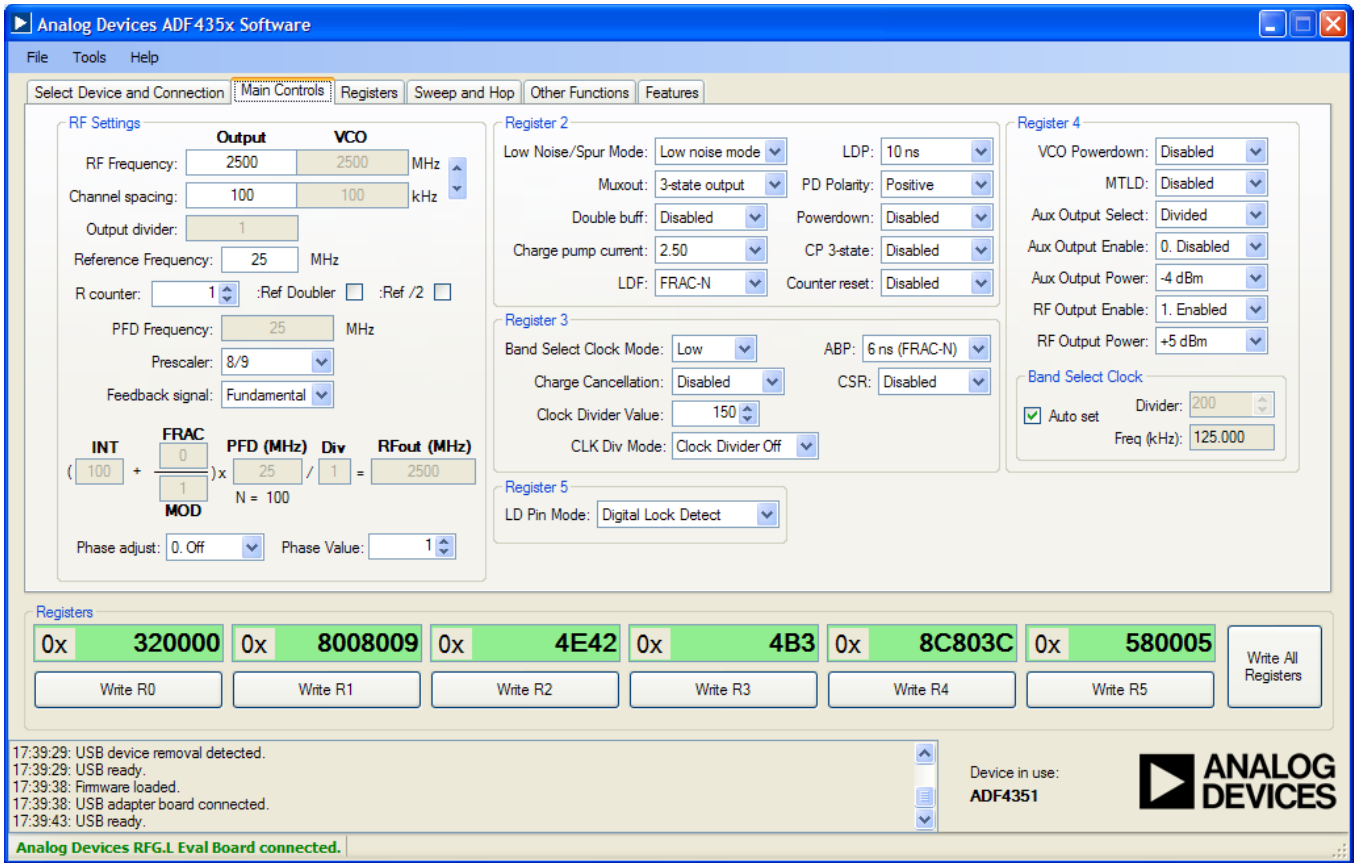

Figure 19. Software Front Panel Display—Main Controls

EVALUATION AND TEST

To evaluate and test the performance of the [ADF4351](#), use the following procedure:

1. Install ADF435x software.
2. Connect the evaluation board to a PC using the supplied USB cable. Follow the hardware driver installation procedure that appears.
3. Connect spectrum analyzer to Connector RF_{OUTA+}.
4. Connect 50 Ω termination to RF_{OUTA-}.
5. Run the ADF435x software.
6. Select the USB board and the [ADF4351](#) device in the **Select Device and Connection** tab of the software front panel window.
7. In the software window, click **Write All Registers**. See Figure 19 for the suggested setup.
8. Measure the output spectrum. Figure 20 shows a phase noise plot at 2.5 GHz output.
9. Different combinations of reference and PFD frequency may require changes to the REFIN stage or PFD frequency. Low output frequencies may require different output stage elements.

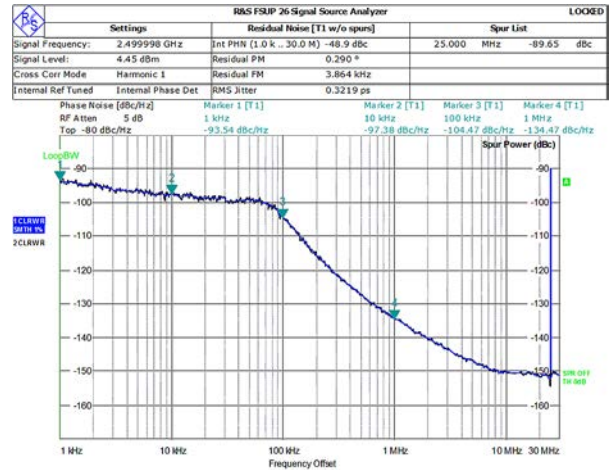

Figure 20. Spectrum Analyzer Display

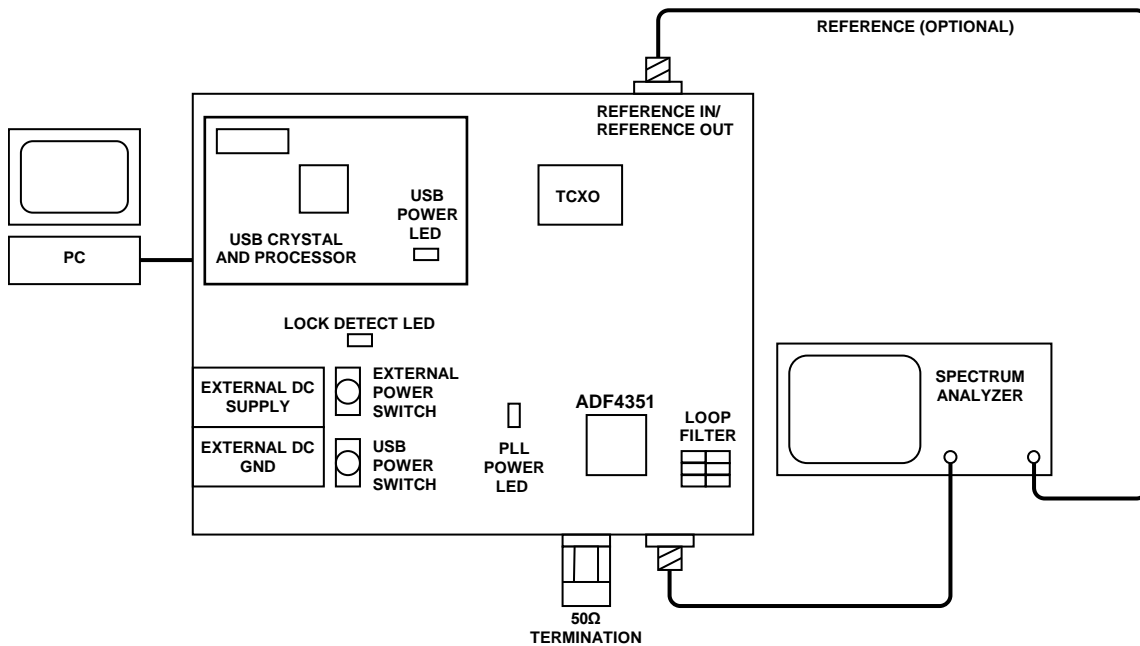
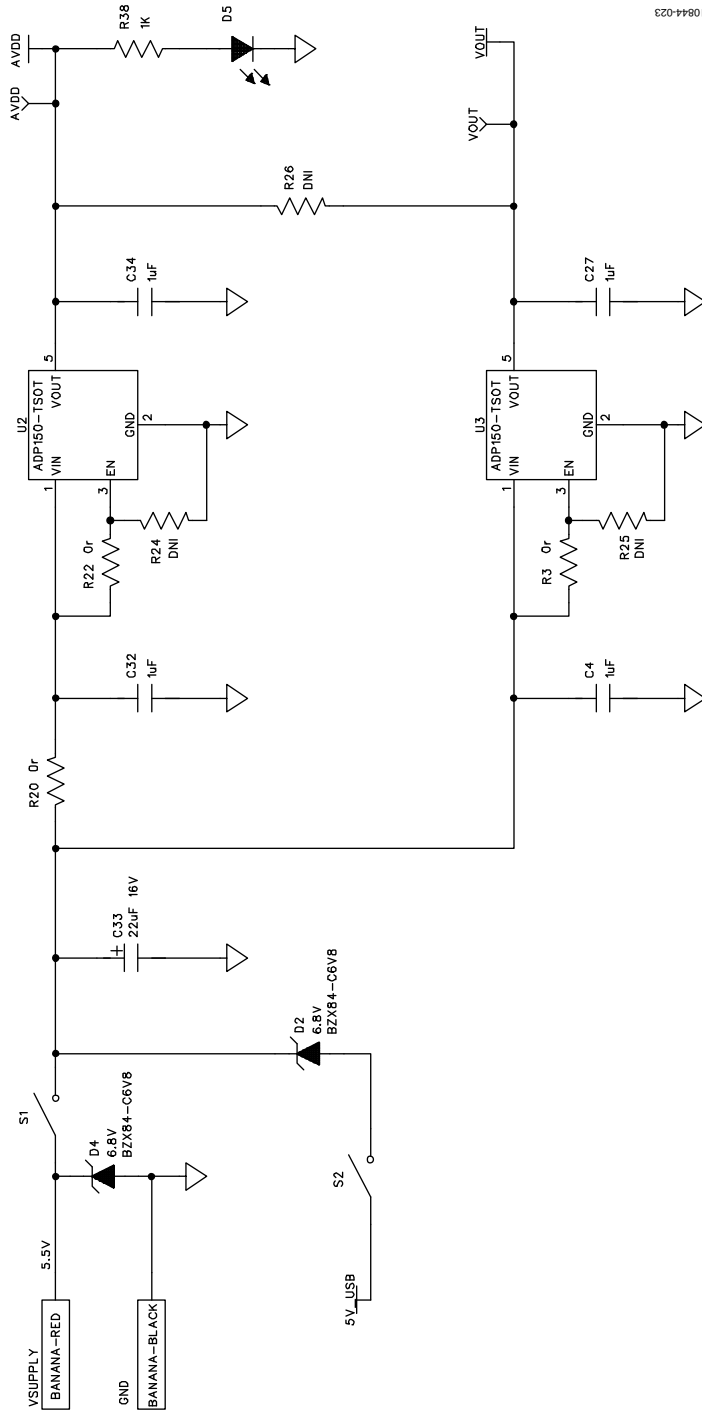

Figure 21. Typical Evaluation Setup



10844-023

Figure 23. Evaluation Board Schematic (Page 2)

10844-024

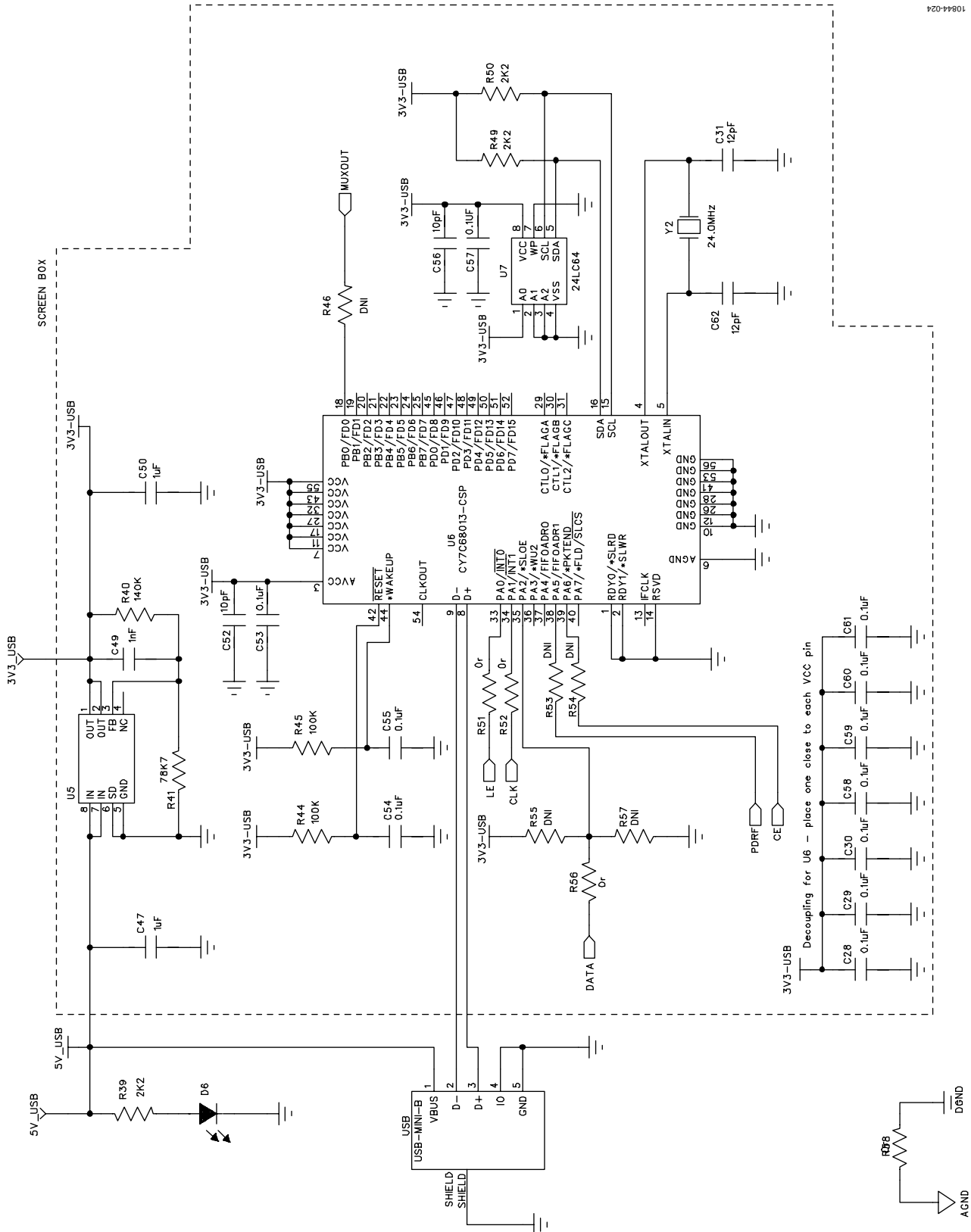
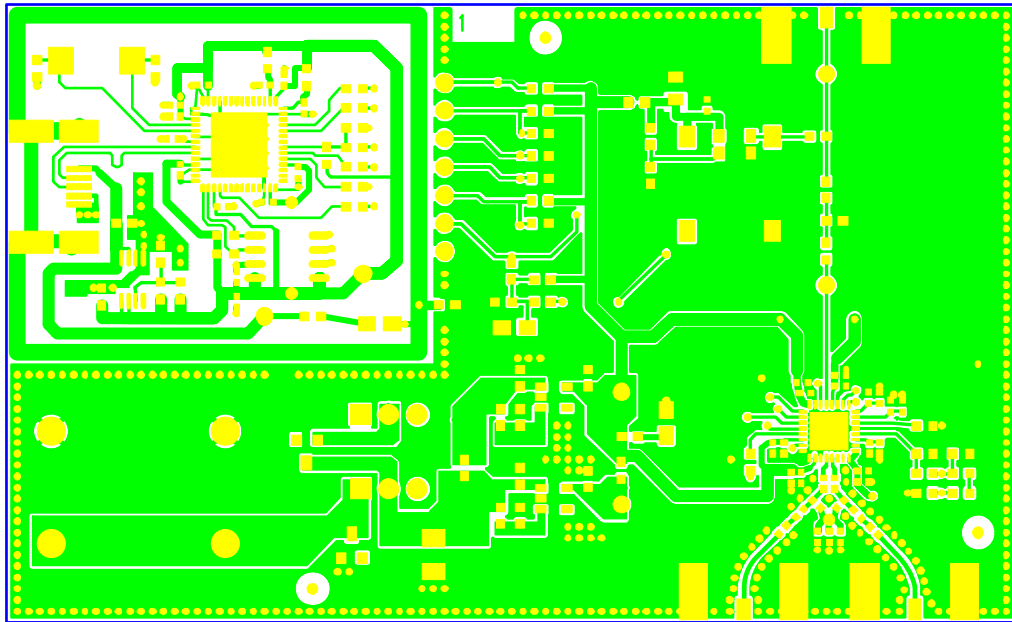
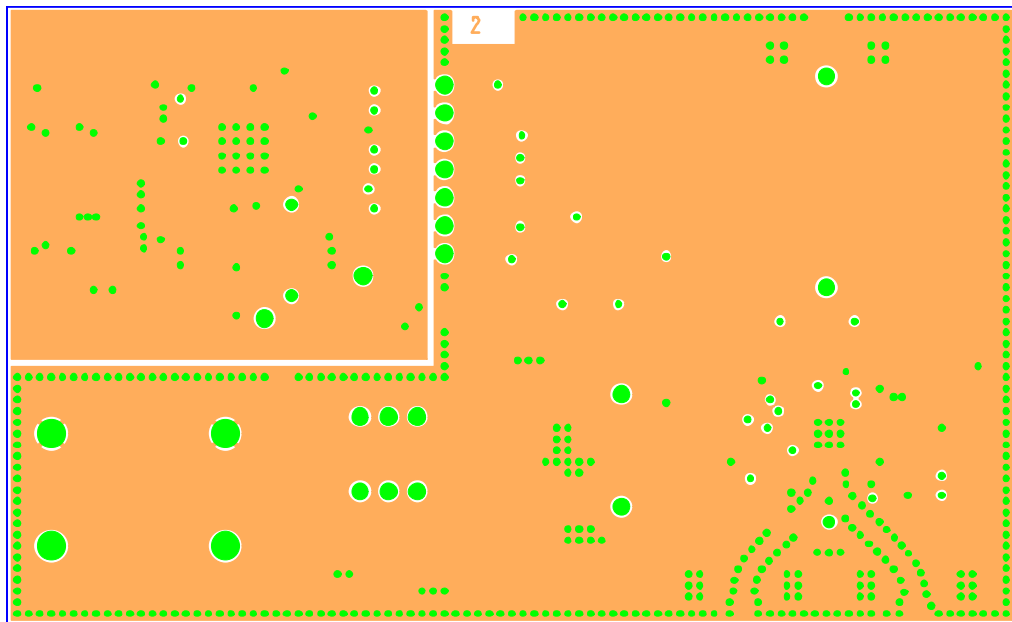

Figure 24. Evaluation Board Schematic (Page 3)



10844-025

Figure 25. Top Side



10844-026

Figure 26. Layer 2 (GND Plane)

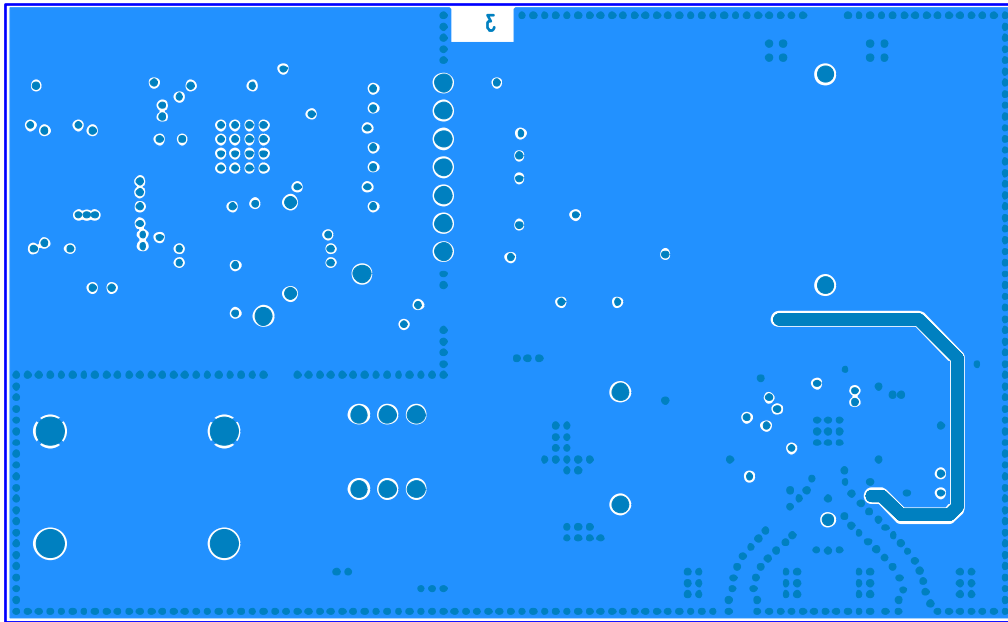

10844-027

Figure 27. Layer 3 (Power Plane)

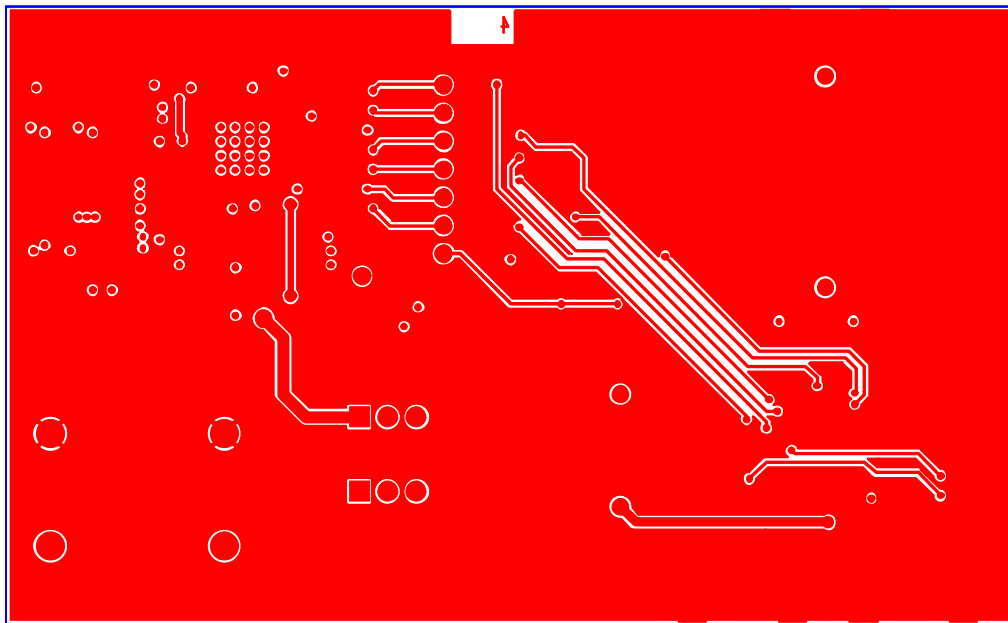

10844-028

Figure 28. Bottom Side

ORDERING INFORMATION

BILL OF MATERIALS

Table 1.

Qty	Reference Designator	Description
1	C1	Ceramic capacitor, 2.7 nF, 0603, 100 V, X7R
1	C2	Ceramic capacitor, 47 nF, 0603, 25 V, X7R
1	C3	Ceramic capacitor, 680 pF, 0603, 50 V, X7R, SMD
4	C4, C27, C32, C34	Capacitor, 1 μ F, 0603, 10 V, X5R
21	C5, C8, C10, C13, C17, C18, C21, C22, C25, C28, C29, C30, C53, C54, C55, C57, C58, C59, C60, C61, C69	Ceramic capacitor, 0.1 μ F, 0402, 16 V, X7R
10	C6, C7, C14, C15, C16, C19, C20, C23, C52, C56	Ceramic capacitor, 10 pF, 0402, 50 V, NP0
1	C9	Ceramic capacitor+, 1 μ F, 0805, RTAJ_A, 16 V, X7R
3	C11, C12, C49	Ceramic capacitor, 1 nF, 0603, 50 V, NP0
2	C24, C36	Ceramic capacitor, 120 pF, 0402, 50 V, NP0
2	C26, C35	Ceramic capacitor, 1 nF, 0402, 50 V, NP0
2	C31, C62	Ceramic capacitor, 12 pF, 0603, 50 V, NPO, SMD
1	C33	Capacitor+, 22 μ F, 16 V, RTAJ_B, tantalum TAJ-B 22UF, 10%
2	C47, C50	Ceramic capacitor, 1 μ F, 0603, 25 V, X5R
2	D1, D6	0805 green LED
2	D2, D4	Zener diode, 6.8 V, SOT23, 350 MW
1	D5	0805 red LED
2	L1, L4	Inductor, 0 Ω 0402 SMD resistor
2	L2, L3	Inductor, 7.5 nH L0402 0402 chip inductor
1	L10	0603 ferrite bead
1	R1	Resistor, 360 Ω , 0603, SMD
2	R2, R38	Resistor, 1 k Ω , 0603, SMD
11	R3, R4, R10, R13, R20, R22, R51, R52, R56, R58, R59	Resistor, 0 Ω , 0603, SMD
13	R5, R6, R8, R9, R11, R14, R18, R21, R46, R53, R54, R55, R57	Resistor location, DNI, 0603—not inserted
3	R7, R44, R45	Resistor 100 Ω 0603 SMD
1	R12	Resistor 4.7 k Ω , 0603, SMD
4	R15, R16, R17, R19	Resistor, 10 k Ω , 0603, SMD
2	R23, R27	Resistor, 0 Ω , 0402, SMD
3	R24 to R26	Resistor, DNI, 0603, SMD
3	R39, R49, R50	Resistor, 2.2 k Ω , 0603, SMD
1	R40	Resistor, 140 k Ω , 0603, SMD
1	R41	Resistor, 78.7 k Ω , 0603, SMD
13	3V3_USB, 5V_USB, AVDD, CE, CLK, DATA, LD, LE, MUXOUT, PDRF, T1, T2, VOUT	Red test point
3	REFIN, RFOUTA+, RFOUTA-	SMA_CARD_EDGE_RF, end-launch 50 Ω SMA jack
2	S1, S2	SW_POWER SW_SIP-3P PCB mount SPDT switch
1	U1	ADF4351 LFCSP-32 PLL
2	U2, U3	ADP150-TSOT TSOT-5 linear regulator
1	U5	ADP3334 MSO8 adjustable LDO regulator
1	U6	CY7C68013-CSP, LFCSP-56_RP, USB microcontroller
1	U7	24LC64, SO8NB, 64K I2C serial EEPROM
1	USB	USB mini-B connector (usb-otg)
1	GND	Black 4 mm banana socket
1	VSUPPLY	Red 4 mm banana socket
1	Y1	OSC_TCXO_IT3200C 26MHz TCXO-IT3200C TCXO
1	Y1 (ALT)	OSC_TCXO-RAKON-TXO200B, 25 MHz, SMD temperature compensated crystal oscillator
1	Y2	XTAL1-CSM-8A, 24.0 MHz, XTAL-CSM-8A, SMD crystal

NOTES

NOTES

NOTES

I²C refers to a communications protocol originally developed by Philips Semiconductors (now NXP Semiconductors).

**ESD Caution**

ESD (electrostatic discharge) sensitive device. Charged devices and circuit boards can discharge without detection. Although this product features patented or proprietary protection circuitry, damage may occur on devices subjected to high energy ESD. Therefore, proper ESD precautions should be taken to avoid performance degradation or loss of functionality.

Legal Terms and Conditions

By using the evaluation board discussed herein (together with any tools, components documentation or support materials, the "Evaluation Board"), you are agreeing to be bound by the terms and conditions set forth below ("Agreement") unless you have purchased the Evaluation Board, in which case the Analog Devices Standard Terms and Conditions of Sale shall govern. Do not use the Evaluation Board until you have read and agreed to the Agreement. Your use of the Evaluation Board shall signify your acceptance of the Agreement. This Agreement is made by and between you ("Customer") and Analog Devices, Inc. ("ADI"), with its principal place of business at One Technology Way, Norwood, MA 02062, USA. Subject to the terms and conditions of the Agreement, ADI hereby grants to Customer a free, limited, personal, temporary, non-exclusive, non-sublicensable, non-transferable license to use the Evaluation Board FOR EVALUATION PURPOSES ONLY. Customer understands and agrees that the Evaluation Board is provided for the sole and exclusive purpose referenced above, and agrees not to use the Evaluation Board for any other purpose. Furthermore, the license granted is expressly made subject to the following additional limitations: Customer shall not (i) rent, lease, display, sell, transfer, assign, sublicense, or distribute the Evaluation Board; and (ii) permit any Third Party to access the Evaluation Board. As used herein, the term "Third Party" includes any entity other than ADI, Customer, their employees, affiliates and in-house consultants. The Evaluation Board is NOT sold to Customer; all rights not expressly granted herein, including ownership of the Evaluation Board, are reserved by ADI. CONFIDENTIALITY. This Agreement and the Evaluation Board shall all be considered the confidential and proprietary information of ADI. Customer may not disclose or transfer any portion of the Evaluation Board to any other party for any reason. Upon discontinuation of use of the Evaluation Board or termination of this Agreement, Customer agrees to promptly return the Evaluation Board to ADI. ADDITIONAL RESTRICTIONS. Customer may not disassemble, decompile or reverse engineer chips on the Evaluation Board. Customer shall inform ADI of any occurred damages or any modifications or alterations it makes to the Evaluation Board, including but not limited to soldering or any other activity that affects the material content of the Evaluation Board. Modifications to the Evaluation Board must comply with applicable law, including but not limited to the RoHS Directive. TERMINATION. ADI may terminate this Agreement at any time upon giving written notice to Customer. Customer agrees to return to ADI the Evaluation Board at that time. LIMITATION OF LIABILITY. THE EVALUATION BOARD PROVIDED HEREUNDER IS PROVIDED "AS IS" AND ADI MAKES NO WARRANTIES OR REPRESENTATIONS OF ANY KIND WITH RESPECT TO IT. ADI SPECIFICALLY DISCLAIMS ANY REPRESENTATIONS, ENDORSEMENTS, GUARANTEES, OR WARRANTIES, EXPRESS OR IMPLIED, RELATED TO THE EVALUATION BOARD INCLUDING, BUT NOT LIMITED TO, THE IMPLIED WARRANTY OF MERCHANTABILITY, TITLE, FITNESS FOR A PARTICULAR PURPOSE OR NON-INFRINGEMENT OF INTELLECTUAL PROPERTY RIGHTS. IN NO EVENT WILL ADI AND ITS LICENSORS BE LIABLE FOR ANY INCIDENTAL, SPECIAL, INDIRECT, OR CONSEQUENTIAL DAMAGES RESULTING FROM CUSTOMER'S POSSESSION OR USE OF THE EVALUATION BOARD, INCLUDING BUT NOT LIMITED TO LOST PROFITS, DELAY COSTS, LABOR COSTS OR LOSS OF GOODWILL. ADI'S TOTAL LIABILITY FROM ANY AND ALL CAUSES SHALL BE LIMITED TO THE AMOUNT OF ONE HUNDRED US DOLLARS (\$100.00). EXPORT. Customer agrees that it will not directly or indirectly export the Evaluation Board to another country, and that it will comply with all applicable United States federal laws and regulations relating to exports. GOVERNING LAW. This Agreement shall be governed by and construed in accordance with the substantive laws of the Commonwealth of Massachusetts (excluding conflict of law rules). Any legal action regarding this Agreement will be heard in the state or federal courts having jurisdiction in Suffolk County, Massachusetts, and Customer hereby submits to the personal jurisdiction and venue of such courts. The United Nations Convention on Contracts for the International Sale of Goods shall not apply to this Agreement and is expressly disclaimed.