

PD70201EVB25F-3

3.3V 25W Isolated Flyback Converter PD

Evaluation Board User Guide

Revision 1.01

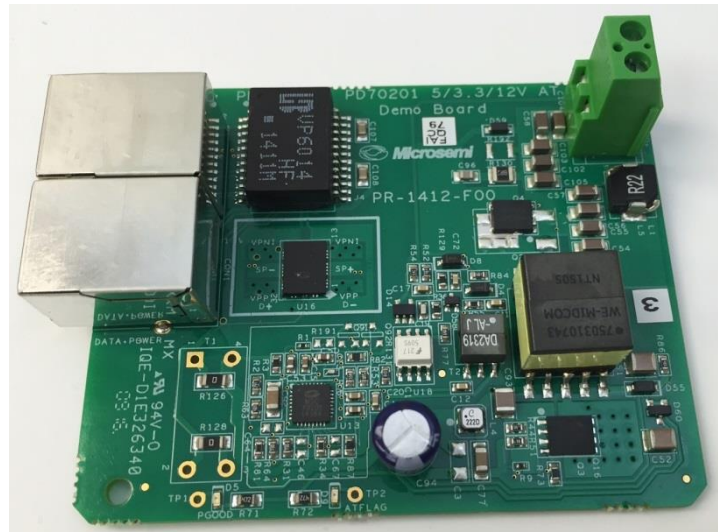

PRODUCTION DATA – Information contained in this document is proprietary to Microsemi and is current as of publication date. This document may not be modified in any way without the express written consent of Microsemi. Product processing does not necessarily include testing of all parameters. Microsemi reserves the right to change the configuration and performance of the product and to discontinue product at any time.



Table of Contents

1 ABOUT THIS GUIDE.....3

1.1 Audience3

1.2 Organization3

1.3 Reference Documents3

2 INTRODUCTION4

2.1 Evaluation Boards Ordering Information5

2.2 Evaluation Board Features.....5

2.3 Physical Characteristics5

3 PHYSICAL DESCRIPTION6

3.1 Package Contents6

3.2 Connectors6

3.3 Indications8

4 ELECTRICAL CHARACTERISTICS9

5 INSTALLATION 10

5.1 Preliminary Considerations and Safety Precautions..... 10

5.2 Initial Configuration 10

6 BOARD TEST WAVEFORMS 11

7 PD70201EVB25F-3 EFFICIENCY 15

7.1 Efficiency for 42.5V Input at the Input Connector 15

7.2 Efficiency for 48V Input at the Input Connector 16

7.3 Efficiency for 57V Input at the Input Connector 16

8 SCHEMATICS..... 18

9 LIST OF MATERIALS 19

10 BOARD LAYOUT 22

1 About this Guide

This user guide provides both a description and operating procedures for Microsemi's PD70201EVB25F-3 board.

This board is intended for evaluating the performance of PD70201 controller.

PD70201ILQ device includes both the standard 802.3at PD application interface, and a PWM controller for the DC/DC converter.

The board supports a 25 Watt, 3.3V output.

1.1 Audience

This user guide is intended for qualified personnel, that is, operators and technicians who have a background in basic concepts of electronics.

1.2 Organization

This guide is arranged according to the following:

- Chapter 0 **About this Guide:** Provides general information about the guide including audience, organization and reference documents.
- Chapter 2 **Introduction:** Provides an overview about evaluation board's main functions, features, physical characteristics and ordering information.
- Chapter 3 **Physical Description:** Provides explanation related to the physical description (switches, jumpers, connectors).
- Chapter 4 **Electrical Characteristics:** Provides electrical characteristics of the evaluation board.
- Chapter 5 **Installation:** Provides a description of the installation process.
- Chapter 6 **Board Test Waveforms:** Provides snapshots of the signals.
- Chapter 7 **PD70201EVB25F-3 Efficiency:** Provides board efficiency information.
- Chapter 8 **Schematic:** Provides a board schematic diagram.
- Chapter 9 **List of Materials:** Provides the board's list of materials.
- Chapter 10 **Board Layout:** Provides board layout files for all layers.

1.3 Reference Documents

- PD70201 datasheet, catalogue number DS_PD70101_70201
- PD70224 datasheet, catalogue number DS_PD70224
- PD70201ILQ system layout Guidelines AN-208



2 Introduction

Microsemi's PD70201ILQ device is part of a family of devices for implementing the 802.3at standard PD interface.

The PD interface family of devices includes the following:

Device type	Power Capability	Integrates PWM Controller	WA_EN support
PD70100	IEEE 802.3at Type 1 (IEEE 802.3 af level)	No	No
PD70101	IEEE 802.3at Type 1 (IEEE 802.3 af level)	Yes	No
PD70200	IEEE 802.3at Type 2	No	No
PD70201	IEEE 802.3at Type 2	Yes	No
PD70210	IEEE 802.3at Type 2	No	No
PD70210A	IEEE 802.3at Type 2	No	Yes
PD70211	IEEE 802.3at Type 2	Yes	Yes

Microsemi's PD70201EVB25F-3 Evaluation Board (see Figure 2) provides designers with the environment needed for evaluating the performance and implementation of PD applications based on the PD70201 device.

The board uses a single PD device, PD70201ILQ, to support the Detection, Class, and Power Supplying phases on the 2/4 Pairs of the Cat5 cable. PD70201ILQ supports a standard IEEE802.3AT Type 2 interface.

All necessary steps and connection instructions required to install and operate this board are provided within this document.

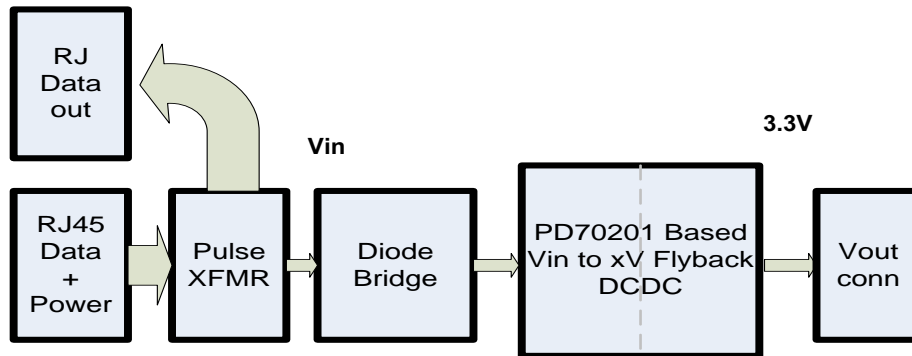

Figure 1: PD70201EVB25F-3 Block Diagram

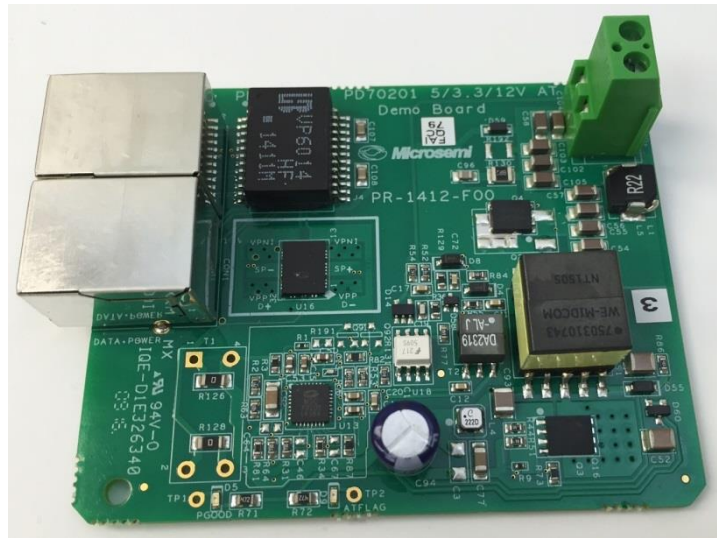

Figure 2: PD70201EVB25F-3 Evaluation Board – General View

2.1 Evaluation Boards Ordering Information

Microsemi's supplies the following Evaluation Boards:

Ordering Number	Description
PD70201EVB25F-3	IEEE802.3AT Type 2 PD, based on PD70201 device, controls an isolated flyback converter , has a 3.3V 7.5A output.

2.2 Evaluation Board Features

- Designed to support Data and Spare current by a single PD70201 device
- Two RJ45 connectors (Data and Power In, Data Out)
- Output voltage connector.
- On board Power Good LED indicator
- On board AT detected LED indicator
- Pulse transformer for routing the data to PD application to enable full PD evaluation.
- Evaluation Board working temperature: -40° to +70°C
- RoHS compliant

2.3 Physical Characteristics

Table 1 lists the evaluation board's physical characteristics.

Table 1: Physical Characteristics

Parameter	Value
Mechanical dimensions in mm	81 x 65 x 15mm (L x W x H)

3 Physical Description

3.1 Package Contents

Upon opening the Evaluation Board package, verify the following part is included; if it appears damaged, contact your local representative or Microsemi's headquarters.

Package content for standard shipments is:

PD70201EVB25F-3 Evaluation Board

3.2 Connectors

The following sections provide both general and detailed information regarding unit's connectors.

3.2.1 Connectors Table

Table 2 lists the Evaluation Board's connectors.

Table 2: Connectors List

#	Connector	Name	Description
1	CON1	RJ45 Connector	RJ45 port for Data and Power In for PSE connection
2	CON2	RJ45 Connectors	RJ45 port for Data Out for PD data connection
4	J1	Converter Output	Terminal blocks for connecting a load to output regulator

3.2.2 Connectors Detailed Explanation

The numbering is in reference to the numbers listed in Table 2.

1. RJ45 Connectors

There are two dedicated RJ45 connectors, See Figure 3.

Table 3: RJ45 Connectors

CON2 Pin No	Signal Name	Description
1, 2, 3, 4, 5, 6, 7, 8	Data Out	Data output to PD
CON1 Pin No	Signal Name	Description
1, 2	Data and Power In	Data and power input to powered device (PoE Master Negative data port)
3, 6	Data and Power In	Data and power input to powered device (PoE Master Positive data port)
4, 5	Data and Power In	Data and power input to powered device (PoE Master Positive data port)
7, 8	Data and Power In	Data and power input to powered device (PoE Master Negative data port)

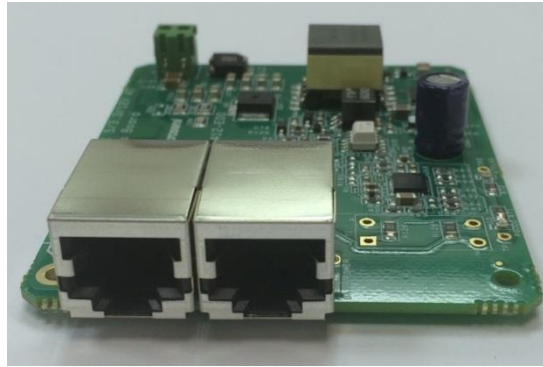

Figure 3: Front RJ45 Connectors

2. Output Connector

See Figure 4.

J1 – DC-DC output connection, used for connecting to external load.

Table 4: J1 Connector

Pin No.	Signal Name	Description
J1 (Left)- Pin 1	Vout	Positive DC-DC output voltage
J1 (Right)-Pin 2	Vout_RTN	Return of DC-DC output voltage

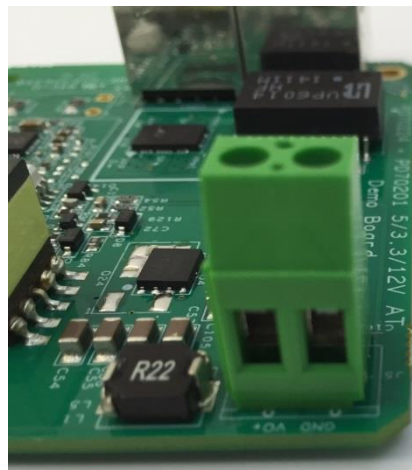

Figure 4: Output Connector

3.3 Indications

The following sections provide general information regarding unit indications.

3.3.1.1 LED Indication

See Figure 5.

D5 is the Power_GOOD indication LED, a PD70201 device output signal indicating if the device isolation switch is in operation. The PWM converter should be turned on only after this signal is active.

D9 is the AT flag indication LED, a PD70201 device output signal indicating that the device has detected two fingers class, thus PSE side is AT level capable. This signal is an indication to the PD environment that AT power level is supported.



Figure 5: LED Indications

4 Electrical Characteristics

Evaluation board's electrical characteristics are described below:

Table 5: Electrical Characteristics

Parameter	Min	Max	
Main DC Supply – Con1, J2	42*	57	V
Output DC voltage	3.2	3.4	V
Maximum Available Current	7.5		A
Port Isolation to Chassis	-	1.5	kVrms

* After start-up, the minimum voltage is 36V with load \leq 13W per IEEE802.3at specification.

5 Installation

5.1 Preliminary Considerations and Safety Precautions

Verify board's power supply is turned "off" before all peripheral devices are connected.

Note: In maximum power at the output, some of the devices may reach high temperatures (still less than 70 degrees). Pay attention while testing these devices.

5.2 Initial Configuration

Note: Prior to starting any operation, it is important to verify that the Evaluation Board is setup as shown in Figure 6.

1. Connect load to main board (J1).
2. Connect a Cat5 cable from PSE to Evaluation Board (CON1). Alternatively connect a power cable from Power supply to Evaluation Board (J2).
3. When there is a need to test the Ethernet data, connect Ethernet cable from Evaluation Board (CON2) to PD Ethernet Host.

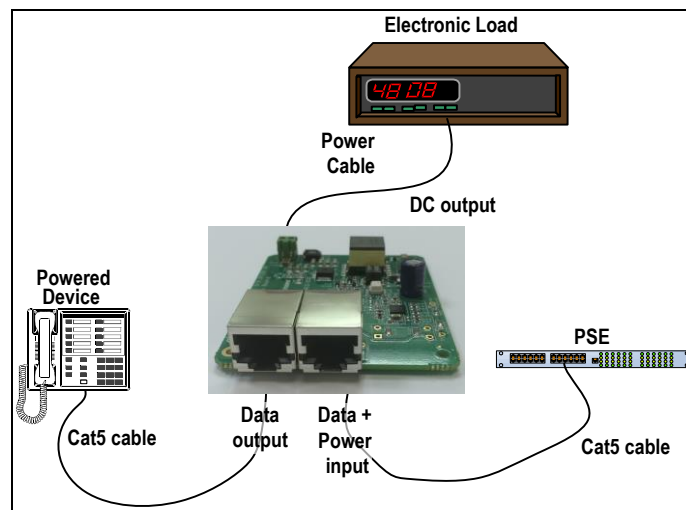

Figure 6: Test Setup

6 Board Test Waveforms

This paragraph presents snapshots of the signals on 3.3V board obtained in Microsemi's lab on a single board.

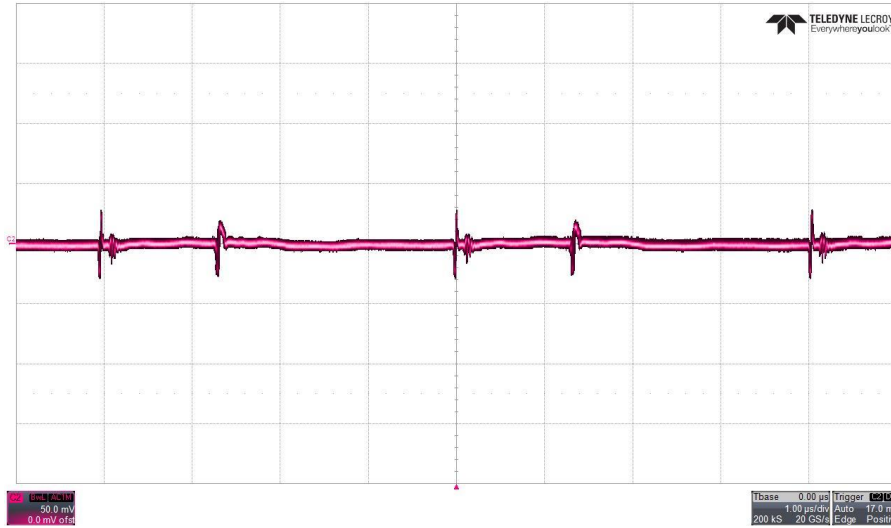

Figure 7: 3.3V/25W Flyback Output Voltage Ripple at Full Load measured with 20 MHz bandwidth

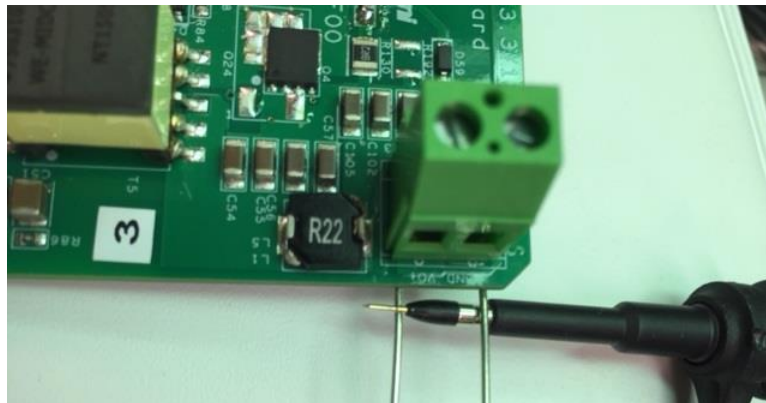

Figure 8: Proper ripple measurement

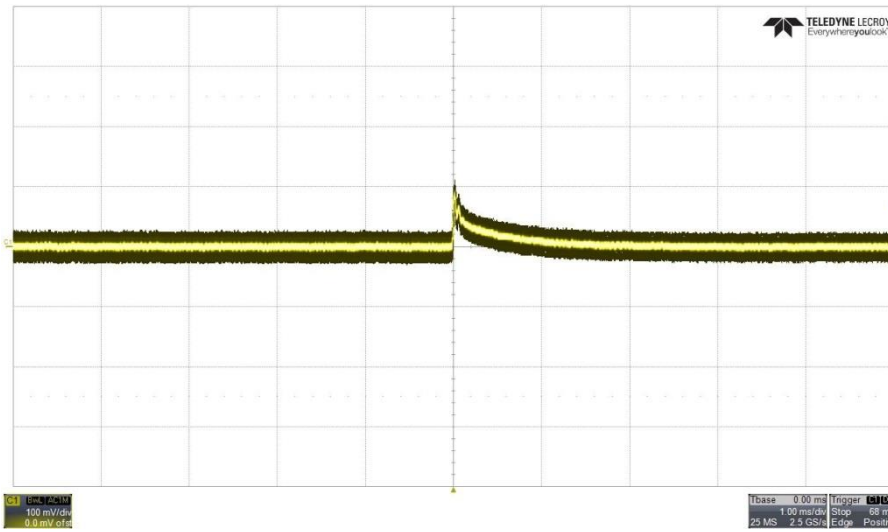

Figure 8: 3.3V/25W Flyback Output Voltage at Load Switching from 7A to 1.5A in 100us

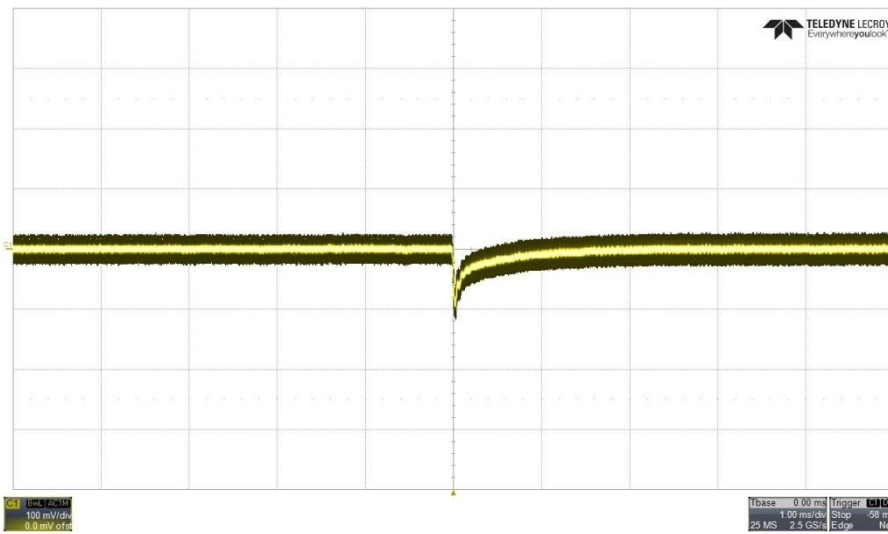

Figure 9: 3.3V/25W Flyback Output Voltage at Load Switching from 1.5A to 7A in 100us

Primary FET switching signal and Secondary FET switching signal:
 Channel 1 is primary FET gate and channel 2 is secondary FET gate.

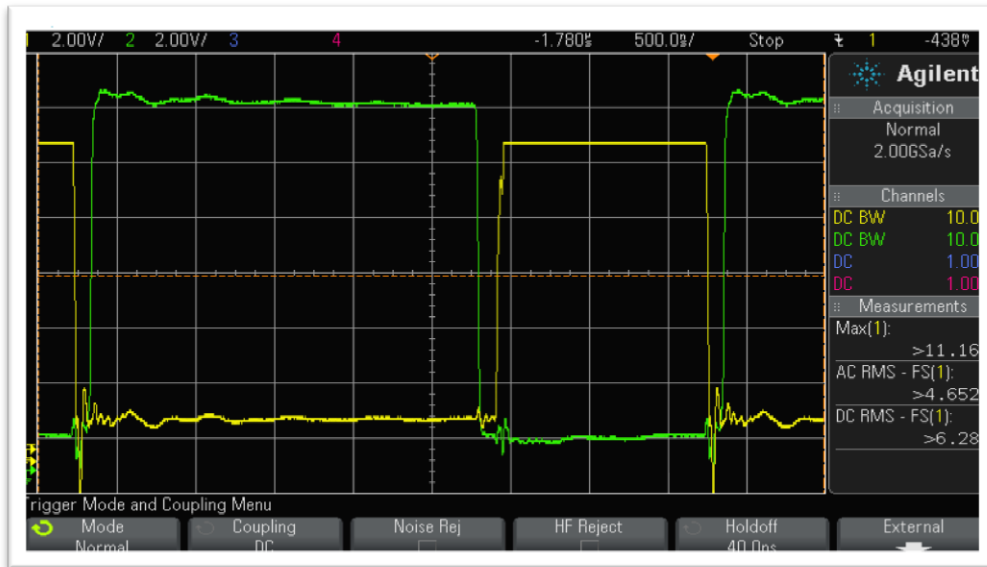

Figure 10: 3.3V/25W Flyback Primary and secondary FETs Gate

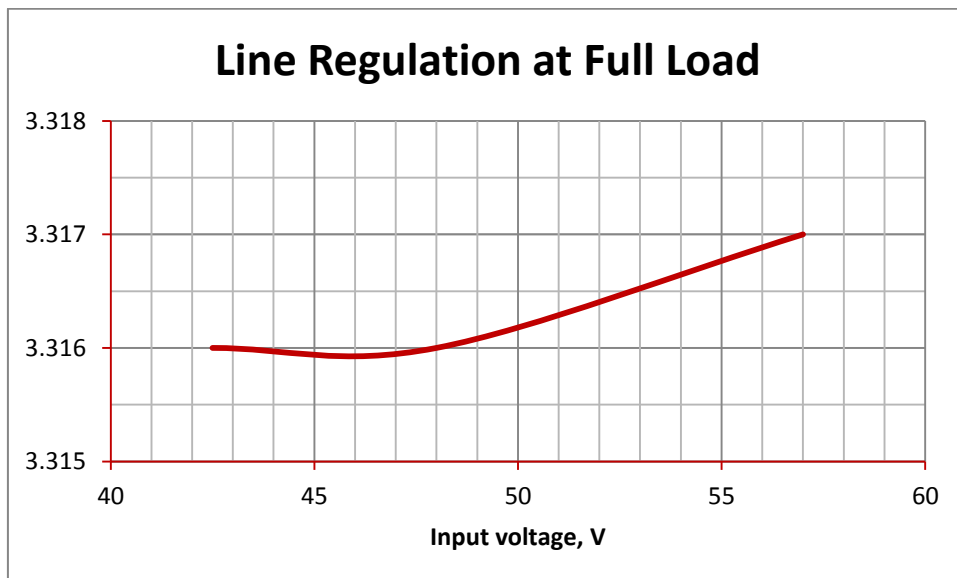

Figure 11: Output Voltage as a Function of Input Voltage



PD70201EVB25F-3 Output Voltage Load Regulation:

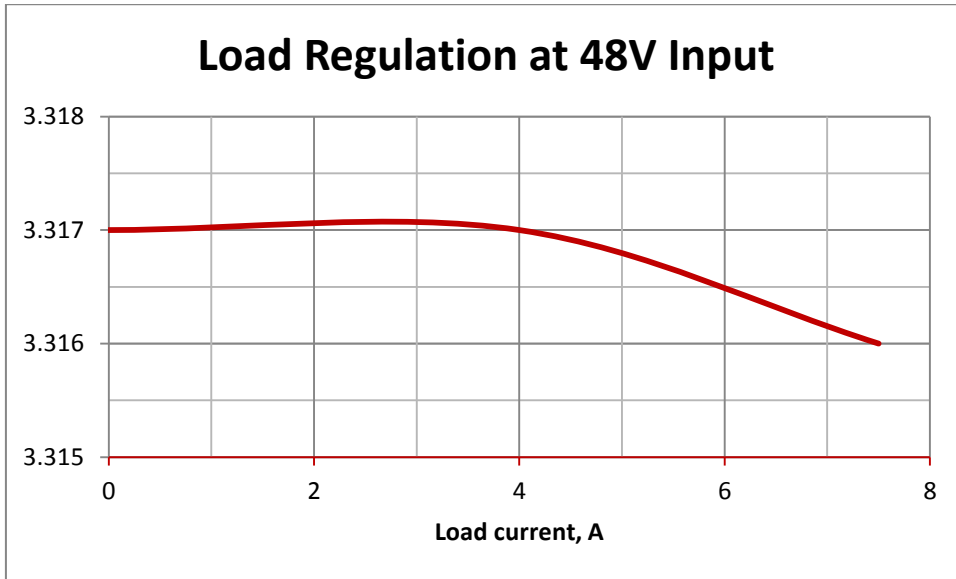

Figure 12: Output Voltage as a Function of the Load Current



7 PD70201EVB25F-3 Efficiency

This chapter describes typical EVB efficiency under various loads and POE input voltage levels.

The information is presented by two modes:

Eff. overall – Efficiency measured between RJ45 input connector and Output voltage connector including the bridge. It does not include losses in the connectors.

$$Total\ Eff = \frac{V_{out} * I_{out}}{V_{in} * I_{in}}$$

PD+DC-DC Eff – Efficiency measured between Diode bridge output and Output voltage connector. It does not include the losses in the connectors, line transformer and diode bridges.

$$PD_DCDC\ Eff = \frac{V_{out} * I_{out}}{V_{ppout} * I_{in}}$$

7.1 Efficiency for 42.5V Input at the Input Connector

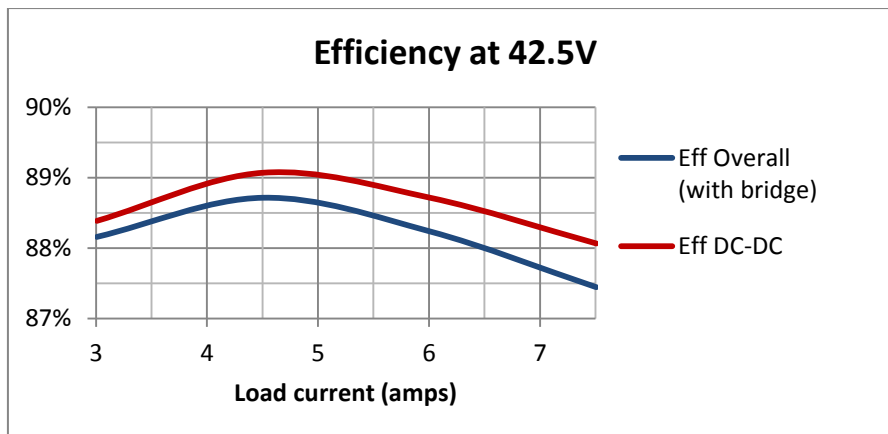

Figure 13: PD70201EVB25F-3 Efficiency at 42.5V

7.2 Efficiency for 48V Input at the Input Connector

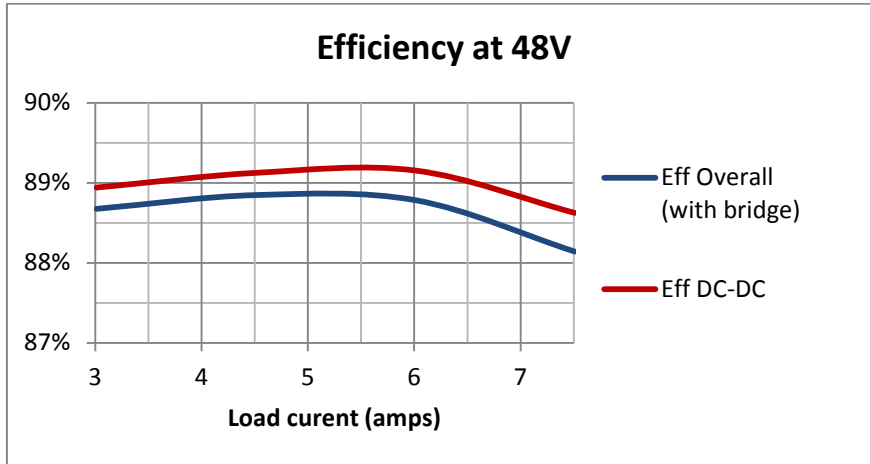

Figure 14: PD70201EVB25F-3 Efficiency at 48V

7.3 Efficiency for 57V Input at the Input Connector

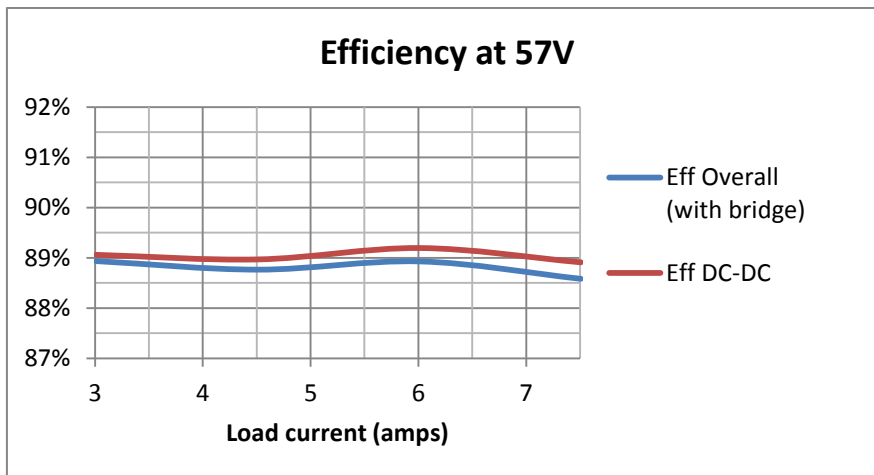

Figure 15: PD70201EVB25F-3 Efficiency at 57V

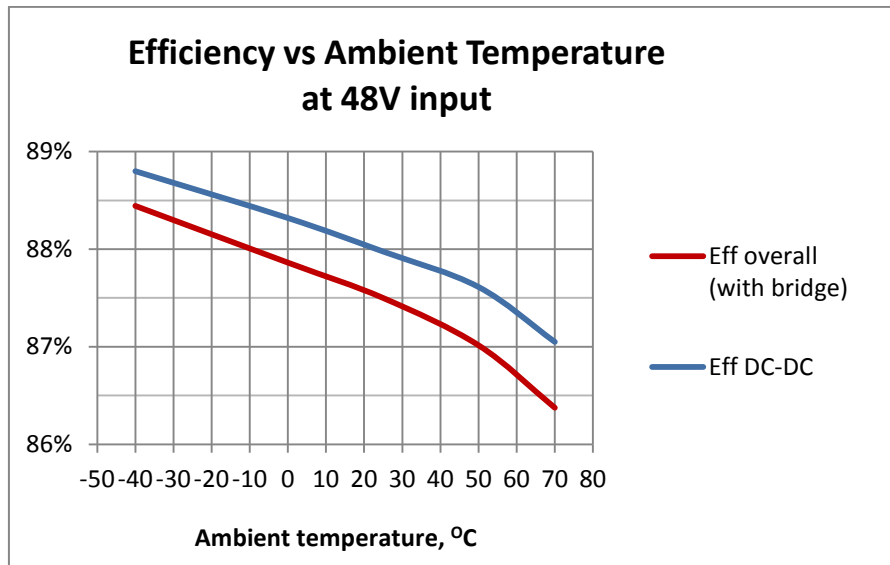

Figure 17: PD70201EVB25F-3 efficiency vs. ambient temperature



8 Schematics

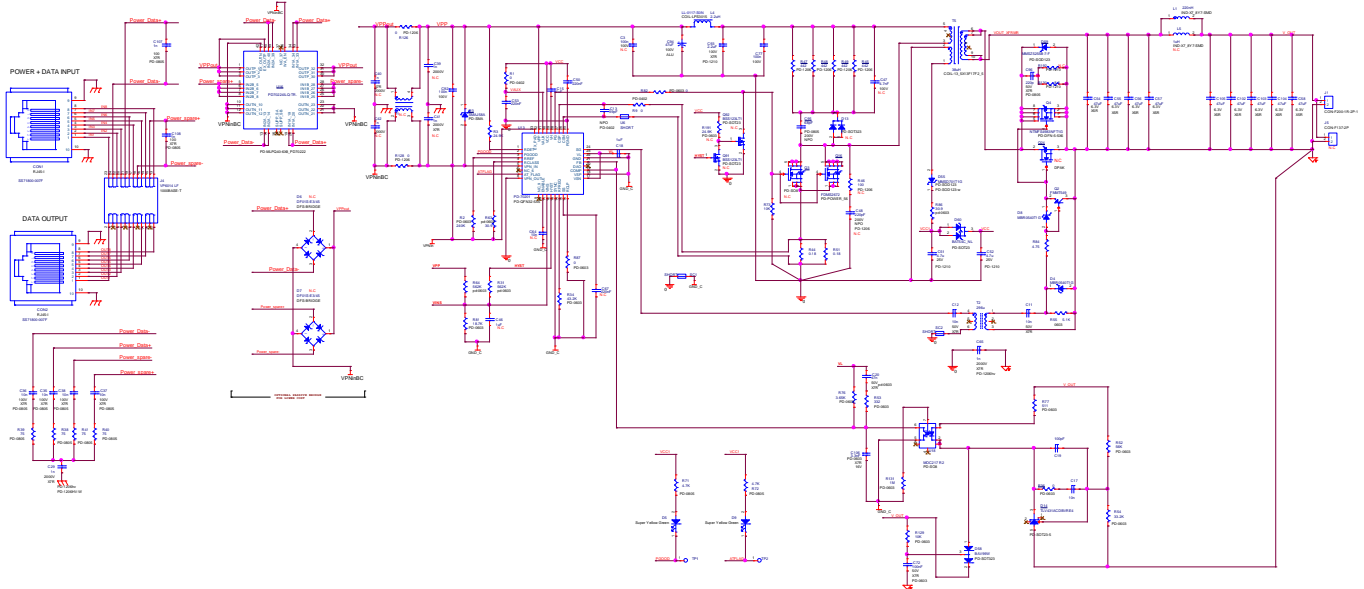

Figure 18: Schematic of PD70201EVB25F-3.



9 List of Materials

Table 6: PD70201EVB25F-3 Assembly

QTY	Reference	Value	Description	Mfr. Name	Mfr. Part Number
2	CON1, CON2	RJ45	CON RJ45 SINGLE 8 POS. SHIELDED	Any	SS71800-007F
3	C11,C12, C17	10n	CAP CRM 10nF 50v 10%X7R 0603 SMT	Rohm	MCH185CN103KK
1	C13	39pF	CAP CRM 39PF 50V 5% COG 0402	Murata	GRM1555C1H390JZ01D
2	C15,C18	1uF	Capacitor,X7R, 1uF, 25V, 10% 0603	Murata	GRM188R71E105KA12D
1	C19	100pF	CAP COG 100pF 50V 5% 0603	TDK	C1608C0G1H101J
1	C20	47n	Capacitor, X7R, 47nF, 50V, 10% 0603	Samsung	CL10B473KB8NNNC
1	C29	1n	CAP CRM 1nF/2000V 10%+X7R 1206 SMT	AVX	1206GC102KAT1A
4	C35,C36, C37,C38	10n	CAP CRM 10nF 100V 5%	Kemet	C0805C103J1RAC
2	C50,C53	220nF	CAP 220NF 25V X7R 10% 0603	TDK	C1608X7R1E224K
2	C51,C52	4.7u	CAP CRM X7R, 4.7uF, 25V, 10% 1210	Taiyo Yuden	TMK325BJ475KN-T
9	C54,C55, C56,C57, C58,C102, C103,C104, C105	47uF	CAP CRM 47UF 6.3V X5R 1206	AVX	12066D476MAT2A
1	C65	1n	CAP CRM 1nF/2000V 10%+X7R 1206 SMT	Walsin	1206B102K202CT
1	C72	100nF	CAP CRM 100nF 50v 10% X7R 0603	Murata	GRM188R71H104KA01
2	C77,C92	100n	CAP CRM 100nF 100V 10% X7R 1206 SMT	AVX	12061C104KAT2A
1	C93	2.2uF	CAP CRM 2.2uF 100V 10% X7R 1210 SMT	TDK	C3225X7R2A225K
1	C94	47uF	CAP ALUM 47uF 100V 20% 8X11.5 105C P=3.5mm T/H	Rubycon	100PX47M EFC T7 8X11.5
1	C95	68pF	CAP CRM 68pF 200V 10% NPO 0805	AVX	08052A680KAT2A
1	C96	220p	CAP CRM 220pF 50V 10% X7R 0805 SMT	Murata	GRM216R71H221KA01D
1	C106	3.3nF	Capacitor, X7R, 3.3nF, 16V, 10% 0603	TDK	C1608X7R1C332K
2	C107,C108	1n	Cap 1nF 100V X7R 0805 10 % SMT	TDK	C2012X7R2A102K



Microsemi

PD70201EVB25Fx

25W Isolated Flyback Converter PD

Evaluation Board

1	D3	SMAJ58A	DIODE TVS 58V 40A SRG400WPK SMA SMT	Vishay	SMAJ58A-13-F
2	D4,D8	MBR0540T	DIODE SCHOTTKY 40V 500mASOD123 REC. SMT	ON Semi	MBR0540T1G
2	D5,D9	19-21-SYGCS530	LED SuperYelGrn 100-130o 20-40mcd h=1 0603 SMD	Everlight	19-21-SYGCS530E3TR8
1	D14	TLV431ACDB	IC PROG. SHUNT REGULATOR1.25V SOT23-5 1% SMT	Texas Inst.	TLV431ACDBVRE4
1	D55	MMSD701T1G	DIODE SCHOTTKY 70V 0.2A,225 W, SOD123	ON Semi	MMSD701T1G
1	D58	BAV99W	Diode, Dual Switching BAV99W SOT323	NXP	BAV99W
1	D59	MMSZ5255B	Diode Zener, 28V 500mW 5% SOD123	Diodes Inc.	MMSZ5255B
1	D60	BAT54C	Diode Schottky Dual 30V CC SOT23 BAT54C	Fairchild	BAT54C_NL
1	J1	ED700/2	TERMINAL BLOCK 5MM 2POS PCB	On Shore Tech	ED700/2
1	J4	VP6014 HF	1000 BASE -T SINGLE PORT VOICE OVER IP MAGNETICS MODULE SMT	BOTHHAND	VP6014 HF
1	L1	220nH	Inductor power 0.22uH 23A shielded SMT	Bourns	SRP7030-R22M
1	L4	2.2uH	Power Inductors 2.2uHy 1.5A 110mOhmSMT Shielded	Coilcraft	LPS3015-222ML
1	Q2	FMMT549	TRN PNP -30V -1A SOT23	Fairchild	FMMT549
1	Q4	NTMFS4983	MOSFET N-CH 30V 160A SO8FL	ON Semi	NTMFS4983NFT1G
1	Q16	FDMS2672	MOSFET N-CH 200V 3.7A POWER56 SMT	Fairchild	FDMS2672
1	R1	0	Resistor, 0 Ohm, 5%, 1/16W 0402	Vishay	CRCW04020000Z0ED
1	R2	240K	Resistor, 240K, 1%, 1/10W 0603	KOA	RK73H1JT2D2403F
1	R3	24.9K	RES TCK FLM 24.9K 62.5mW 1%0603 SMT	Samsung	RC1608F2492CS
1	R9	0	Resistor, 0 Ohm, 5%, 1/16W 0402	Rohm	MCR01MZPJ000
2	R31,R64	562K	RES 562K, 1%, 1/16W, 0603	Samsung	RC1608F5623CS
1	R34	43.2K	RES 43.2K 100mW 0603SMT 1%	Panasonic	ERJ3EKF4322V
2	R36,R82	0	RES TCK FLM 0R 62.5mW 5% 0603 SMT	Rohm	MCR03EZPJ000
4	R38,R39, R40,R41	75	RES 75R 125mW 1% 0805 SMT	Bourns	CR0805-FX-75R0-E
2	R44,R51	0.18	RES TCK FLM 0.18R 0.1W 1% 0603 SMT	Bourns	CRL0603-FW-R180ELF
4	R45,R47, R48,R49	442	RES 442R 250mW 1% 1206SMT	Stackpole Electr.	RMCF1206FT442R



Microsemi

PD70201EVB25Fx

25W Isolated Flyback Converter PD

Evaluation Board

1	R52	56K	Resistor, SMT 56K, 1%, 1/10W 0603	Vishay	CRCW060356K0FKEA
1	R53	332	RES 332R 62.5mW 1%0603 SMT MTL FLM	Yageo	RC0603FRF07332R
1	R54	33.2K	RES 33.2K 62.5mW 1%0603 SMT MTL FLM	Samsung	RC1608F3322CS
1	R55	5.1K	RES TCK FLM 5.1K 62.5mW 1%0603 SMT	Vishay	CRCW06035K1FKEA
2	R63,R86	30.9	Resistor, 30.9R 1%, 1/10W 0603	Panasonic	ERJ3EKF30R9V
2	R71,R72	4.7K	RES 4.7K 125mW 5% 0805SMT MTL FLM	Bourns	CR0805-JW-472ELF
1	R73	10K	RES 10K 62.5mW 1%0603 SMT MTL FLM	Rohm	MCR03EZPFX1002
1	R76	3.65K	RES 3.65K 0.1W 1%0603 SMT MTL FLM	Panasonic	ERJ3EKF3651V
1	R77	511	RES 511R 100mW 1% 0603 SMT MTL FLM	Panasonic	ERJ3EKF5110V
1	R81	18.7K	Resistor, 18.7K, 1%, 1/16W	ASJ	CR16-1872FL
1	R84	4.75	RES 4.75R 0.1W 1%0603 SMT MTL FLM	Vishay	CRCW06034R75FKEA
1	R87	0	RES TCK FLM 0R 62.5mW 5% 0603 SMT	Samsung	RC1608J000CS
2	R126,R128	0	RES 0R 250mW 5%1206 SMT JUMPER<0.05R	Samsung	RC3216J000CS
1	R129	10K	RES 10K 62.5mW 1%0603 SMT MTL FLM	Samsung	RC1608F1002CS
1	R130	8.2	RES 8.2R 1/2W 5% 1210	KOA	RK73B2ETTD8R2J
1	R131	1M	RES 1M 62.5mW 1%0603 SMT MTL FLM	Yageo	RC0603FRF071M
1	T2	296u	Transformer, Gate driver SMT 269uH 0.795 DCR	Coilcraft	DA2319-AL
1	T5	38uH	TRANS FLYBACK POE 38uH SMD	Tesla Magnetics	TX4012
1	U13	PD70201	AT POE PD controller for IEEE 802.3 PD70201	Microsemi	PD70201ILQ-TR
1	U16	PD70224	Ideal Diode Bridge dual 6x8 SMT PD70224	Microsemi	PD70224ILQ-TR
1	U18	MOC217	IC OPTOISOLATOR MOC217	Fairchild	MOC217 R2



10 Board Layout

This paragraph presents the layout of the evaluation board.

The board is a 2-layer board. The layers are 2 Oz layers. The figures below present the two copper layers and the silk of the board for tracking devices placements.

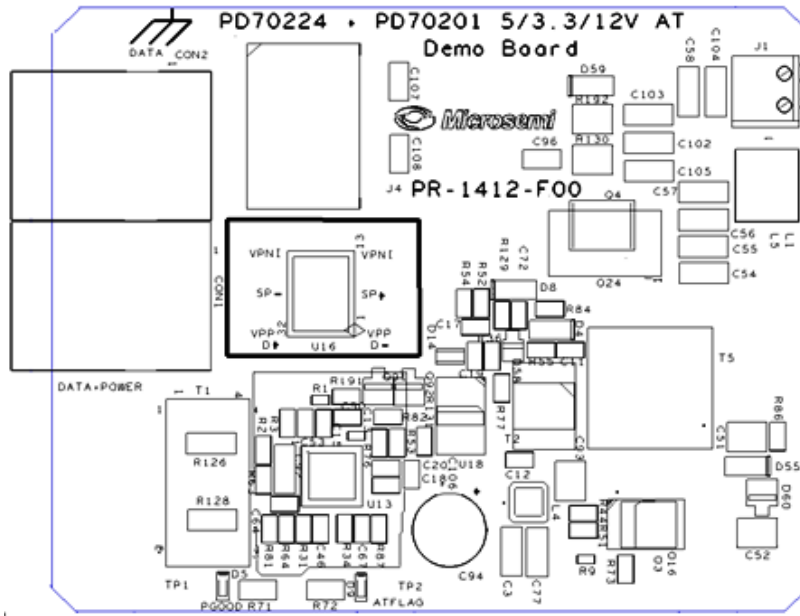

Figure 19: Top Silk

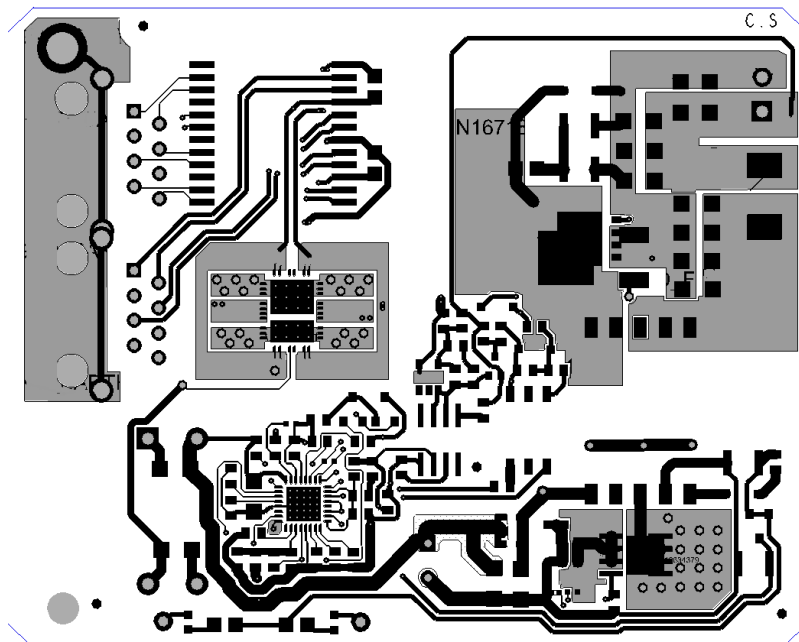

Figure 20: Top Layer

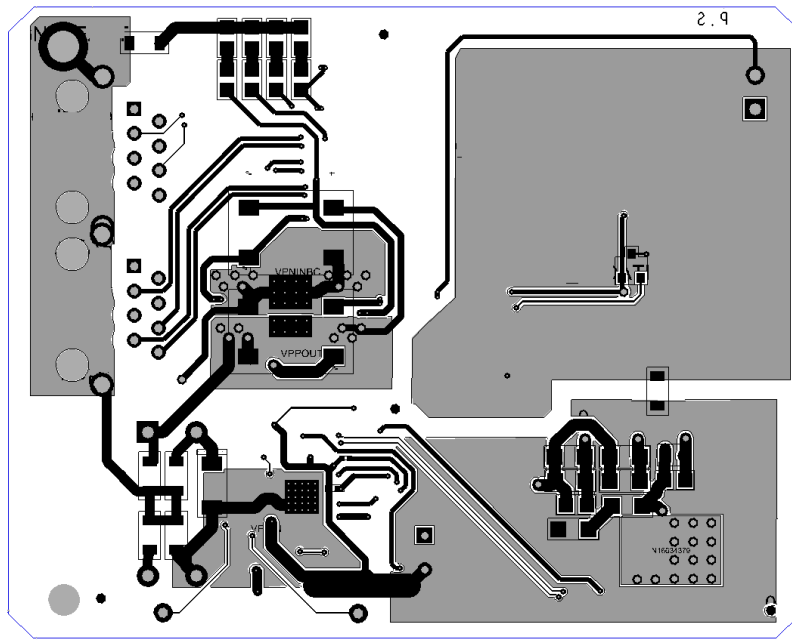

Figure 16: Bottom Layer

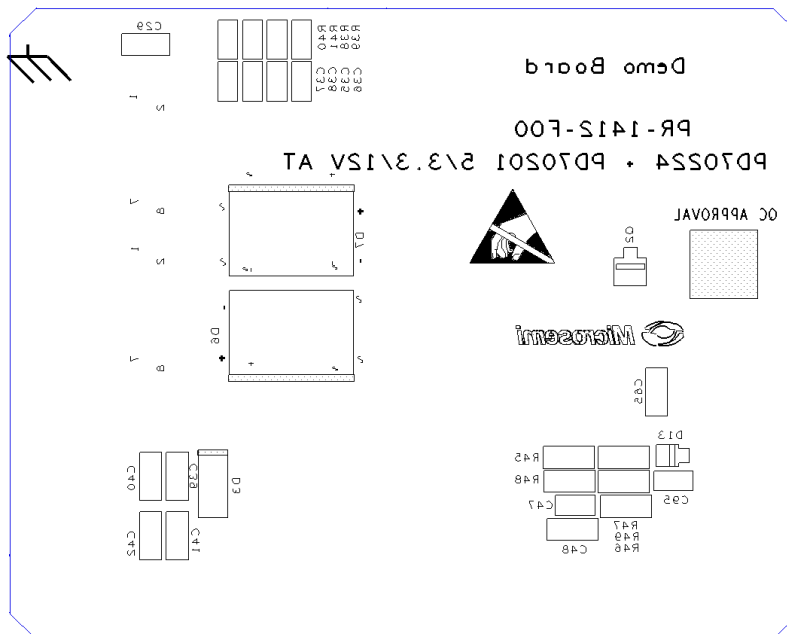

Figure 17: Bottom Silk



The information contained in the document (unless it is publicly available on the Web without access restrictions) is PROPRIETARY AND CONFIDENTIAL information of Microsemi and cannot be copied, published, uploaded, posted, transmitted, distributed or disclosed or used without the express duly signed written consent of Microsemi. If the recipient of this document has entered into a disclosure agreement with Microsemi, then the terms of such Agreement will also apply. This document and the information contained herein may not be modified, by any person other than authorized personnel of Microsemi. No license under any patent, copyright, trade secret or other intellectual property right is granted to or conferred upon you by disclosure or delivery of the information, either expressly, by implication, inducement, estoppels or otherwise. Any license under such intellectual property rights must be approved by Microsemi in writing signed by an officer of Microsemi.

Microsemi reserves the right to change the configuration, functionality and performance of its products at any time without any notice. This product has been subject to limited testing and should not be used in conjunction with life-support or other mission-critical equipment or applications. Microsemi assumes no liability whatsoever, and Microsemi disclaims any express or implied warranty, relating to sale and/or use of Microsemi products including liability or warranties relating to fitness for a particular purpose, merchantability, or infringement of any patent, copyright or other intellectual property right. Any performance specifications believed to be reliable but are not verified and customer or user must conduct and complete all performance and other testing of this product as well as any user or customers final application. User or customer shall not rely on any data and performance specifications or parameters provided by Microsemi. It is the customer's and user's responsibility to independently determine suitability of any Microsemi product and to test and verify the same. The information contained herein is provided "AS IS, WHERE IS" and with all faults, and the entire risk associated with such information is entirely with the User. Microsemi specifically disclaims any liability of any kind including for consequential, incidental and punitive damages as well as lost profit. The product is subject to other terms and conditions which can be located on the web at <http://www.microsemi.com/company/terms-and-conditions>

Revision History

Revision Level / Date	Para. Affected/Page	Description
Rev 1.01		Initial release

© 2016 Microsemi Corp.

All rights reserved.

For support contact: PoEsupport@microsemi.com

Visit our web site at www.microsemi.com

Catalog Number: PD70201EVB25F-3_UG