

# Schnelle GaAs-IR-Lumineszenzdiode (950 nm) High-Speed GaAs Infrared Emitter (950 nm)

SFH 4203

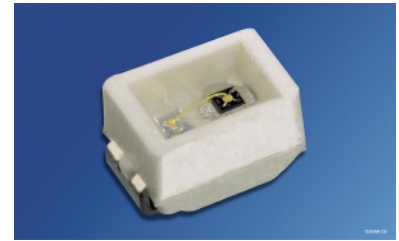

## Wesentliche Merkmale

- GaAs-LED mit sehr hohem Wirkungsgrad
- Gute Linearität ( $I_e = f[I_F]$ ) bei hohen Strömen
- Gleichstrom- (mit Modulation) oder Impulsbetrieb möglich
- Hohe Zuverlässigkeit
- Hohe Impulsbelastbarkeit
- Für Oberflächenmontage geeignet
- Gegurtet lieferbar

## Anwendungen

- Miniaturlichtschranken für Gleich- und Wechsellichtbetrieb, Lochstreifenleser
- Industrieelektronik
- „Messen/Steuern/Regeln“
- Automobiltechnik
- Sensorik
- Alarm- und Sicherungssysteme
- IR-Freiraumübertragung

## Features

- Very highly efficient GaAs-LED
- Good Linearity ( $I_e = f[I_F]$ ) at high currents
- DC (with modulation) or pulsed operations are possible
- High reliability
- High pulse handling capability
- Suitable for surface mounting (SMT)
- Available on tape and reel

## Applications

- Miniature photointerrupters
- Industrial electronics
- For drive and control circuits
- Automotive technology
- Sensor technology
- Alarm and safety equipment
- IR free air transmission

Typ Type	Bestellnummer Ordering Code	Gehäuse Package
SFH 4203	Q62702-P5232	Mini TOPLED® Anodenkennzeichnung: abgesetzte Ecke Anode marking: bevelled edge

**Grenzwerte** ( $T_A = 25\text{ °C}$ )**Maximum Ratings**

Bezeichnung Parameter	Symbol Symbol	Wert Value	Einheit Unit
Betriebs- und Lagertemperatur Operating and storage temperature range	$T_{op}; T_{stg}$	- 40 ... + 100	°C
Sperrspannung Reverse voltage	$V_R$	3	V
Durchlassstrom Forward current	$I_F$ (DC)	100	mA
Stoßstrom, $t_p = 10\text{ }\mu\text{s}$ , $D = 0$ Surge current	$I_{FSM}$	1	A
Verlustleistung Power dissipation	$P_{tot}$	180	mW
Wärmewiderstand Sperrschicht - Umgebung bei Montage auf FR4 Platine, Padgröße je $16\text{ mm}^2$ Thermal resistance junction - ambient mounted on PC-board (FR4), pads size $16\text{ mm}^2$ each	$R_{thJA}$	450	K/W
Wärmewiderstand Sperrschicht - Lötstelle bei Montage auf Metall-Block Thermal resistance junction - soldering point, mounted on metal block	$R_{thJS}$	200	K/W

**Kennwerte** ( $T_A = 25\text{ °C}$ )**Characteristics**

Bezeichnung Parameter	Symbol Symbol	Wert Value	Einheit Unit
Wellenlänge der Strahlung Wavelength at peak emission $I_F = 100\text{ mA}$ , $t_p = 20\text{ ms}$	$\lambda_{peak}$	950	nm
Spektrale Bandbreite bei 50% von $I_{max}$ Spectral bandwidth at 50% of $I_{max}$ $I_F = 100\text{ mA}$ , $t_p = 20\text{ ms}$	$\Delta\lambda$	40	nm
Abstrahlwinkel Half angle	$\varphi$	$\pm 65$	Grad deg.
Aktive Chipfläche Active chip area	$A$	0.09	$\text{mm}^2$
Abmessungen der aktiven Chipfläche Dimensions of the active chip area	$L \times B$ $L \times W$	$0.3 \times 0.3$	mm

Kennwerte ( $T_A = 25\text{ °C}$ )

Characteristics (cont'd)

Bezeichnung Parameter	Symbol Symbol	Wert Value	Einheit Unit
Schaltzeiten, $I_e$ von 10% auf 90% und von 90% auf 10%, bei $I_F = 100\text{ mA}$ , $t_p = 20\text{ ms}$ , $R_L = 50\ \Omega$ Switching times, $I_e$ from 10% to 90% and from 90% to 10%, $I_F = 100\text{ mA}$ , $t_p = 20\text{ ms}$ , $R_L = 50\ \Omega$	$t_r$ , $t_f$	10	ns
Durchlassspannung, Forward voltage $I_F = 100\text{ mA}$ , $t_p = 20\text{ ms}$ $I_F = 1\text{ A}$ , $t_p = 100\ \mu\text{s}$	$V_F$ $V_F$	1.5 ( $\leq 1.8$ ) 3.2 ( $\leq 3.6$ )	V V
Sperrstrom, Reverse current $V_R = 3\text{ V}$	$I_R$	0.01 ( $\leq 10$ )	$\mu\text{A}$
Gesamtstrahlungsfluss, Total radiant flux $I_F = 100\text{ mA}$ , $t_p = 20\text{ ms}$	$\Phi_e$	28	mW
Temperaturkoeffizient von $I_e$ bzw. $\Phi_e$ , $I_F = 100\text{ mA}$ Temperature coefficient of $I_e$ or $\Phi_e$ , $I_F = 100\text{ mA}$	$TC_I$	- 0.44	%/K
Temperaturkoeffizient von $V_F$ , $I_F = 100\text{ mA}$ Temperature coefficient of $V_F$ , $I_F = 100\text{ mA}$	$TC_V$	- 1.5	mV/K
Temperaturkoeffizient von $\lambda$ , $I_F = 100\text{ mA}$ Temperature coefficient of $\lambda$ , $I_F = 100\text{ mA}$	$TC_\lambda$	+ 0.2	nm/K

**Strahlstärke  $I_e$  in Achsrichtung**gemessen bei einem Raumwinkel  $\Omega = 0.01\text{ sr}$ **Radiant Intensity  $I_e$  in Axial Direction**at a solid angle of  $\Omega = 0.01\text{ sr}$ 

Bezeichnung Parameter	Symbol	Werte Values	Einheit Unit
Strahlstärke Radiant intensity $I_F = 100\text{ mA}$ , $t_p = 20\text{ ms}$	$I_{e\text{ min.}}$ $I_{e\text{ typ.}}$	4 6.5	mW/sr mW/sr
Strahlstärke Radiant intensity $I_F = 1\text{ A}$ , $t_p = 100\ \mu\text{s}$	$I_{e\text{ typ.}}$	45	mW/sr

**Relative Spectral Emission**

$I_{rel} = f(\lambda)$

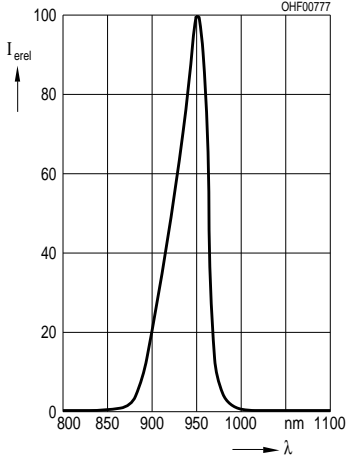

**Radiant Intensity**  $\frac{I_e}{I_e 100 \text{ mA}} = f(I_F)$

Single pulse,  $t_p = 20 \mu\text{s}$

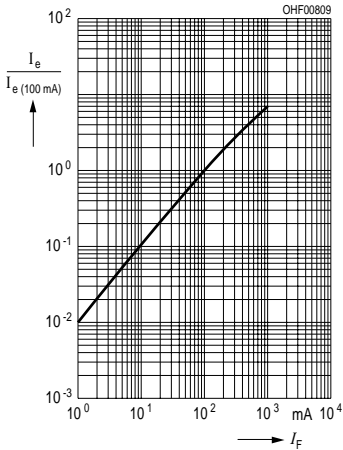

**Forward Current**  $I_F = f(V_F)$

single pulse,  $t_p = 20 \mu\text{s}$

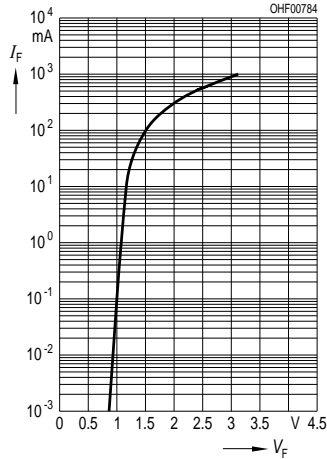

**Max. Permissible Forward Current**

$I_F = f(T_A, R_{thJA}^1)$

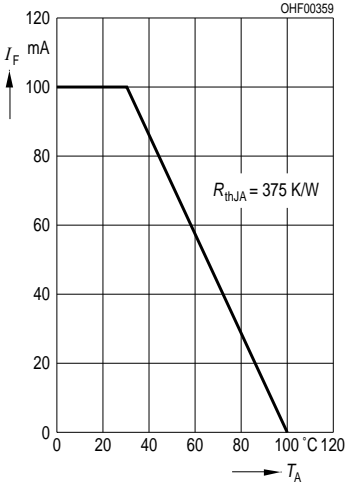

**Radiation Characteristics**  $I_{rel} = f(\varphi)$

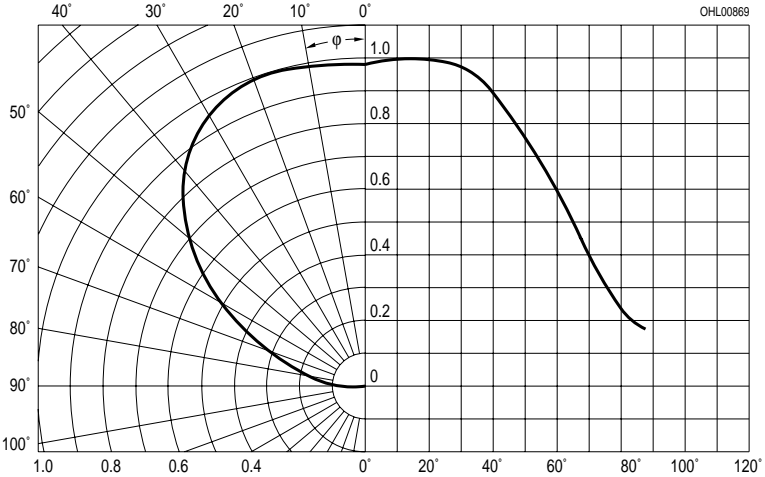

1) Thermal resistance junction - ambient mounted on PC-board (FR4), pad size 16 mm<sup>2</sup> (each).

Maßzeichnung  
Package Outlines

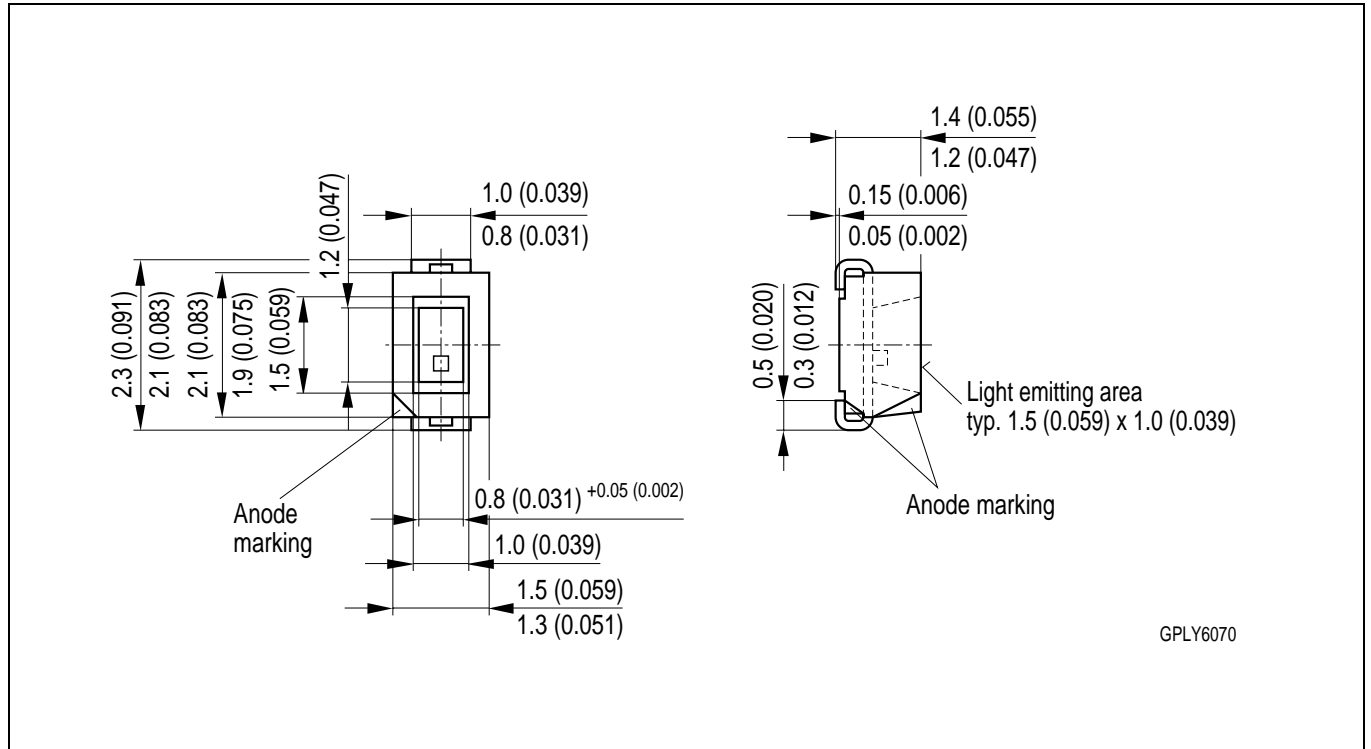

Maße werden wie folgt angegeben: mm (inch) / Dimensions are specified as follows: mm (inch).

## Löthinweise Soldering Conditions

Bauform Types	Reflowlötung Reflow Soldering	
	Lötzonentemperatur Temperature of Soldering Zone	Maximale Durchlaufzeit Max. Transit Time
Mini TOPLED®	245 °C	10 s

Zusätzliche Informationen über allgemeine Lötbedingungen erhalten Sie auf Anfrage.

For additional information on general soldering conditions please contact us.

**Published by OSRAM Opto Semiconductors GmbH & Co. OHG**

**Wernerwerkstrasse 2, D-93049 Regensburg**

**© All Rights Reserved.**

**Attention please!**

The information describes the type of component and shall not be considered as assured characteristics.

Terms of delivery and rights to change design reserved. Due to technical requirements components may contain dangerous substances. For information on the types in question please contact our Sales Organization.

### **Packing**

Please use the recycling operators known to you. We can also help you – get in touch with your nearest sales office. By agreement we will take packing material back, if it is sorted. You must bear the costs of transport. For packing material that is returned to us unsorted or which we are not obliged to accept, we shall have to invoice you for any costs incurred.

**Components used in life-support devices or systems must be expressly authorized for such purpose!** Critical components <sup>1</sup>, may only be used in life-support devices or systems <sup>2</sup> with the express written approval of OSRAM OS.

<sup>1</sup> A critical component is a component used in a life-support device or system whose failure can reasonably be expected to cause the failure of that life-support device or system, or to affect its safety or effectiveness of that device or system.

<sup>2</sup> Life support devices or systems are intended (a) to be implanted in the human body, or (b) to support and/or maintain and sustain human life. If they fail, it is reasonable to assume that the health of the user may be endangered.