



Grayhill, Inc.

70M-IDC15

Part Number:

70M-IDC15

Producent / marka:

Grayhill, Inc.

Opis produktu

DC INPUT MODULE 3-32V

Arkusze danych:

 70M-IDC15.pdf

Status RoHS

 Bezołowiowa / zgodna z RoHS

Statek z

Hongkong

Sposób wysyłki

DHL/Fedex/TNT/UPS/EMS

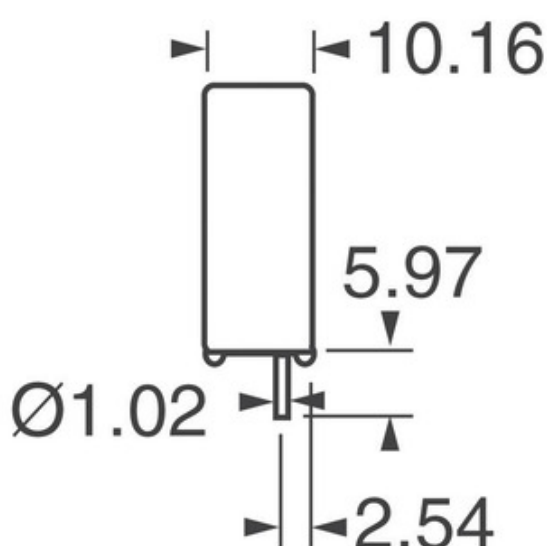

PROŚBA O OFERTĘ

Obraz może być reprezentacją. Zobacz specyfikację dla szczegółów produktu.







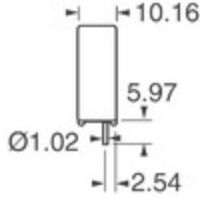
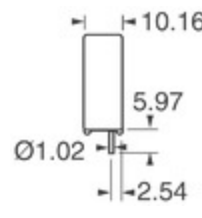
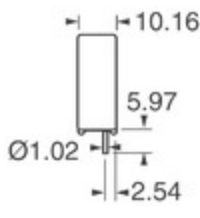

Specyfikacje 70M-IDC15

PART NUMBER	70M-IDC15
PRODUCENT	Grayhill, Inc.
OPIS	DC INPUT MODULE 3-32V
STAN OŁOWIU / STATUS ROHS	Bezołowiowa / zgodna z RoHS
ARKUSZ DANYCH	 70M-IDC15.pdf
NAPIĘCIE - WYJŚCIE	15VDC
NAPIĘCIE - WEJŚCIE	3 ~ 32VDC
RODZAJ	DC Input Module
TURN ON TIME	0.20ms
WYŁĄCZ CZAS	0.40ms
STYL	Mini
SERIA	70
POZIOM CZUŁOŚCI NA WILGOĆ (MSL)	1 (Unlimited)
STANDARDOWY CZAS OCZEKIWANIA PRODUCENTA	3 Weeks
STATUS BEZOŁOWIOWY / STATUS ROHS	Lead free / RoHS Compliant
CECHY	-
SZCZEGÓŁOWY OPIS	DC Input Module Output Module 10mA 15VDC Output 3 ~ 32VDC Supply
OBECNY - WYJŚCIE	10mA
OBECNY - WEJŚCIE	18mA
KOLOR	White

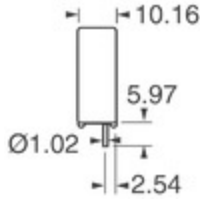
Powiązane tagi

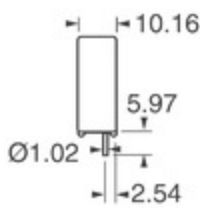
Grayhill, Inc. 70M-IDC15	Dystrybutor 70M-IDC15	Dostawca 70M-IDC15
Cena 70M-IDC15	Zdjęcia 70M-IDC15	Obraz 70M-IDC15
Arkusze danych 70M-IDC15 PDF	70M-IDC15 Pobierz arkusz danych	Arkusze danych 70M-IDC15
Zdjęcie 70M-IDC15	Kup 70M-IDC15	Kup Grayhill, Inc. 70M-IDC15
Grayhill, Inc. 70M-IDC15	Grayhill, Inc. Dostawca	Dystrybutor Grayhill, Inc.
Grayhill, Inc. 70M-IDC15	Grayhill Inc. 70M-IDC15	

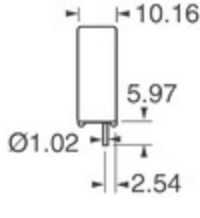
Produkty powiązane

 <p>70M-JUMP6 Producent: Grayhill, Inc. Opis: 6 POS JUMPER FOR MINI I/O RACKS Na stanie: Out stock</p> <p>RFQ</p>	 <p>70M-IAC15A Producent: Grayhill, Inc. Opis: AC INPUT MODULE 240V Na stanie: Out stock</p> <p>RFQ</p>
 <p>70M-IAC24A Producent: Grayhill, Inc. Opis: AC INPUT MODULE 240V Na stanie: Out stock</p> <p>RFQ</p>	 <p>70M-IDC24 Producent: Grayhill, Inc. Opis: DC INPUT MODULE 3-32V Na stanie: Out stock</p> <p>RFQ</p>
 <p>70M-IDC5NP Producent: Grayhill, Inc. Opis: AC/DC INPUT MOD 15-32V/10-32V Na stanie: Out stock</p> <p>RFQ</p>	 <p>70M-IAC15 Producent: Grayhill, Inc. Opis: AC INPUT MODULE 120V Na stanie: Out stock</p> <p>RFQ</p>
 <p>70M-IAC5A Producent: Grayhill, Inc. Opis: AC INPUT MODULE 240V Na stanie: 37 pcs</p> <p>RFQ</p>	 <p>70M-IDC5N Producent: Grayhill, Inc. Opis: AC/DC INPUT MODULE 35-60V Na stanie: Out stock</p> <p>RFQ</p>
 <p>70M-IDC5G Producent: Grayhill, Inc. Opis: AC/DC INPUT MODULE 35-60V Na stanie: Out stock</p> <p>RFQ</p>	 <p>70M-IAC24 Producent: Grayhill, Inc. Opis: AC INPUT MODULE 120V Na stanie: Out stock</p> <p>RFQ</p>
 <p>70M-IDC5 Producent: Grayhill, Inc. Opis: DC INPUT MODULE 3-32V Na stanie: 891 pcs</p> <p>RFQ</p>	 <p>70M-IAC5 Producent: Grayhill, Inc. Opis: AC INPUT MODULE 120V Na stanie: 795 pcs</p> <p>RFQ</p>