

Data Sheet

HAL[®] 556, HAL 566

Two-Wire Hall-Effect Sensors

Copyright, Warranty, and Limitation of Liability

The information and data contained in this document are believed to be accurate and reliable. The software and proprietary information contained therein may be protected by copyright, patent, trademark and/or other intellectual property rights of Micronas. All rights not expressly granted remain reserved by Micronas.

Micronas assumes no liability for errors and gives no warranty representation or guarantee regarding the suitability of its products for any particular purpose due to these specifications.

By this publication, Micronas does not assume responsibility for patent infringements or other rights of third parties which may result from its use. Commercial conditions, product availability and delivery are exclusively subject to the respective order confirmation.

Any information and data which may be provided in the document can and do vary in different applications, and actual performance may vary over time.

All operating parameters must be validated for each customer application by customers' technical experts. Any new issue of this document invalidates previous issues. Micronas reserves the right to review this document and to make changes to the document's content at any time without obligation to notify any person or entity of such revision or changes. For further advice please contact us directly.

Do not use our products in life-supporting systems, military, aviation, or aerospace applications! Unless explicitly agreed to otherwise in writing between the parties, Micronas' products are not designed, intended or authorized for use as components in systems intended for surgical implants into the body, or other applications intended to support or sustain life, or for any other application in which the failure of the product could create a situation where personal injury or death could occur.

No part of this publication may be reproduced, photocopied, stored on a retrieval system or transmitted without the express written consent of Micronas.

Micronas Trademarks

– HAL

Third-Party Trademarks

All other brand and product names or company names may be trademarks of their respective companies.

Contents

Page	Section	Title
4	1.	Introduction
4	1.1.	Features
4	1.2.	Family Overview
5	2.	Ordering Information
5	2.1.	Device-Specific Ordering Codes
6	3.	Functional Description
7	4.	Specification
7	4.1.	Outline Dimensions
12	4.2.	Solderability and Welding
12	4.3.	Pin Connections and Short Descriptions
12	4.4.	Physical Dimension
12	4.4.1.	Sensitive Area
12	4.4.2.	Position
13	4.5.	Absolute Maximum Ratings
13	4.5.1.	Storage and Shelf Life
13	4.6.	Recommended Operating Conditions
14	4.7.	Characteristics
15	4.8.	Magnetic Characteristics Overview
18	5.	Type Description
18	5.1.	HAL556
20	5.2.	HAL566
22	6.	Application Notes
22	6.1.	Application Circuit
22	6.2.	Extended Operating Conditions
22	6.3.	Start-up Behavior
23	6.4.	Ambient Temperature
23	6.5.	EMC and ESD
24	7.	Data Sheet History

Two-Wire Hall-Effect Sensors

Release Note: Revision bars indicate significant changes to the previous edition.

1. Introduction

This sensor family consists of different two-wire Hall switches produced in CMOS technology. All sensors change the current consumption depending on the external magnetic field and require only two wires between sensor and evaluation circuit. The sensors of this family differ in the magnetic switching behavior and switching points.

The sensors include a temperature-compensated Hall plate with active offset compensation, a comparator, and a current source. The comparator compares the actual magnetic flux through the Hall plate (Hall voltage) with the fixed reference values (switching points). Accordingly, the current source is switched on (high current consumption) or off (low current consumption).

The active offset compensation leads to constant magnetic characteristics in the full supply voltage and temperature range. In addition, the magnetic parameters are robust against mechanical stress effects.

The sensors are designed for industrial and automotive applications and operate with supply voltages from 4 V to 24 V in the junction temperature range from -40 °C up to 140 °C. All sensors are available in the SMD-package SOT89B-1 and in the leaded versions TO92UA-1 and TO92UA-2.

1.1. Features

- Current output for two-wire applications
- Junction temperature range from -40 °C up to 140 °C.
- Operates from 4 V to 24 V supply voltage
- Operates with static magnetic fields and dynamic magnetic fields up to 10 kHz
- Switching offset compensation at typically 145 kHz
- Overvoltage and reverse-voltage protection
- magnetic characteristics are robust against mechanical stress effects
- Constant magnetic switching points over a wide supply voltage range
- The decrease of magnetic flux density caused by rising temperature in the sensor system is compensated by a built-in negative temperature coefficient of the magnetic characteristics
- Ideal sensor for applications in extreme automotive and industrial environments
- EMC corresponding to ISO 7637

1.2. Family Overview

The types differ according to the mode of switching and the magnetic switching points.

Type	Switching Behavior	Sensitivity	see Page
556	unipolar	very high	18
566	unipolar inverted	very high	20

Unipolar Switching Sensors:

The sensor turns to high current consumption with the magnetic south pole on the branded side of the package and turns to low consumption if the magnetic field is removed. The sensor does not respond to the magnetic north pole on the branded side.

Unipolar Inverted Switching Sensors:

The sensor turns to low current consumption with the magnetic south pole on the branded side of the package and turns to high consumption if the magnetic field is removed. The sensor does not respond to the magnetic north pole on the branded side.

2. Ordering Information

A Micronas device is available in a variety of delivery forms. They are distinguished by a specific ordering code:

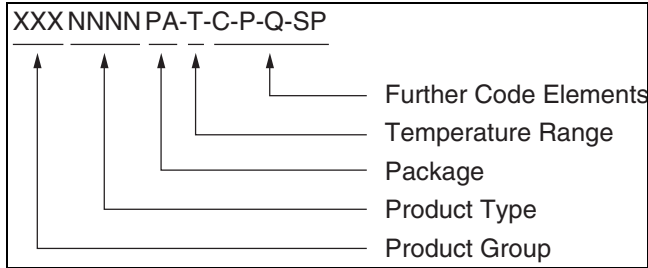

Fig. 2–1: Ordering Code Principle

For a detailed information, please refer to the brochure: “Hall Sensors: Ordering Codes, Packaging, Handling”

2.1. Device-Specific Ordering Codes

HAL556, HAL566 is available in the following package and temperature variants.

Table 2–1: Available packages

Package Code (PA)	Package Type
UA	TO92UA
SF	SOT89B-1

Table 2–2: Available temperature ranges

Temperature Code (T)	Temperature Range
E	$T_J = -40\text{ °C to }+100\text{ °C}$
K	$T_J = -40\text{ °C to }+140\text{ °C}$

The relationship between ambient temperature (T_A) and junction temperature (T_J) is explained in Section 5.4. on page 29.

For available variants for Configuration (C), Packaging (P), Quantity (Q), and Special Procedure (SP) please contact Micronas.

Table 2–3: Available ordering codes and corresponding package marking

Available Ordering Codes	Package Marking
HAL556UA-E-[C-P-Q-SP]	556E
HAL556UA-K-[C-P-Q-SP]	556K
HAL566SF-E-[C-P-Q-SP]	566E
HAL566SF-K-[C-P-Q-SP]	566K

3. Functional Description

The two-wire sensors HAL556 and HAL566 are monolithic integrated circuits which switch in response to magnetic fields. If a magnetic field with flux lines perpendicular to the sensitive area is applied to the sensor, the biased Hall plate forces a Hall voltage proportional to this field. The Hall voltage is compared with the actual threshold level in the comparator. The temperature-dependent bias increases the supply voltage of the Hall plates and adjusts the switching points to the decreasing induction of magnets at higher temperatures.

If the magnetic field exceeds the threshold levels, the current source switches to the corresponding state. In the low current consumption state, the current source is switched off and the current consumption is caused only by the current through the Hall sensor. In the high current consumption state, the current source is switched on and the current consumption is caused by the current through the Hall sensor and the current source. The built-in hysteresis eliminates oscillation and provides switching behavior of the output signal without bouncing.

Magnetic offset caused by mechanical stress is compensated for by using the “switching offset compensation technique”. An internal oscillator provides a two-phase clock. In each phase, the current is forced through the Hall plate in a different direction, and the Hall voltage is measured. At the end of the two phases, the Hall voltages are averaged and thereby the offset voltages are eliminated. The average value is compared with the fixed switching points. Subsequently, the current consumption switches to the corresponding state. The amount of time elapsed from crossing the magnetic switching level to switching of the current level can vary between zero and $1/f_{osc}$.

Shunt protection devices clamp voltage peaks at the VSUP-pin together with external series resistors. Reverse current is limited at the VSUP-pin by an internal series resistor up to -15 V. No external protection diode is needed for reverse voltages ranging from 0 V to -15 V.

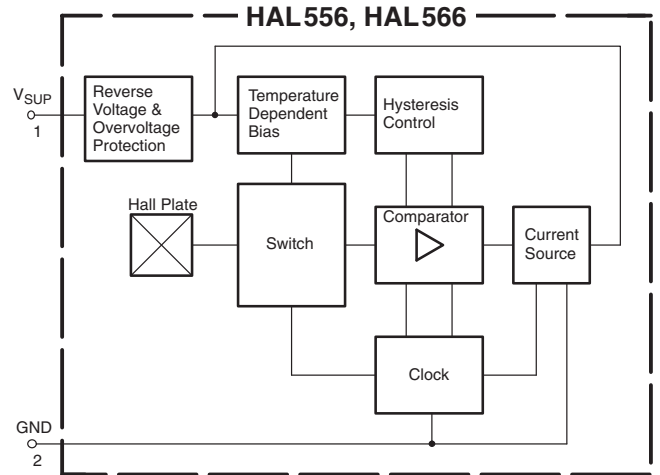

Fig. 3-1: HAL556, HAL566 block diagram

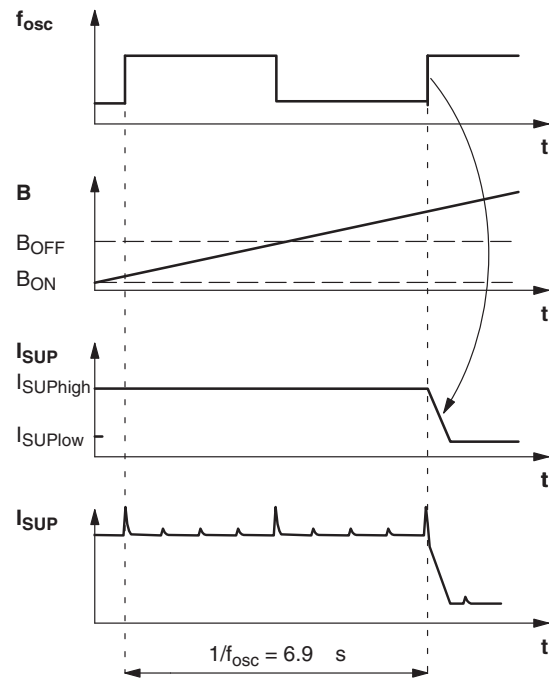

Fig. 3-2: Timing diagram (example HAL566)

4. Specification

4.1. Outline Dimensions

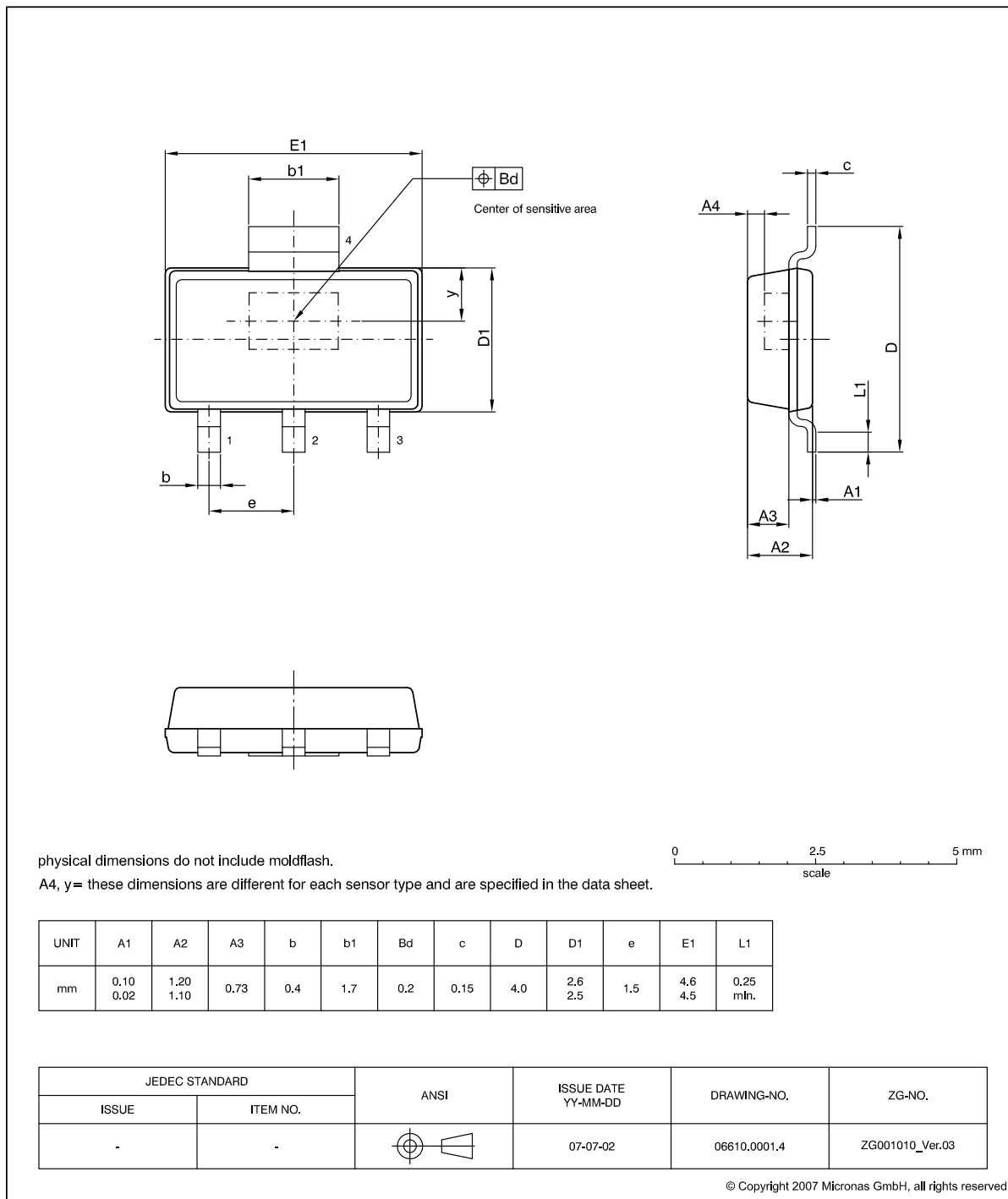
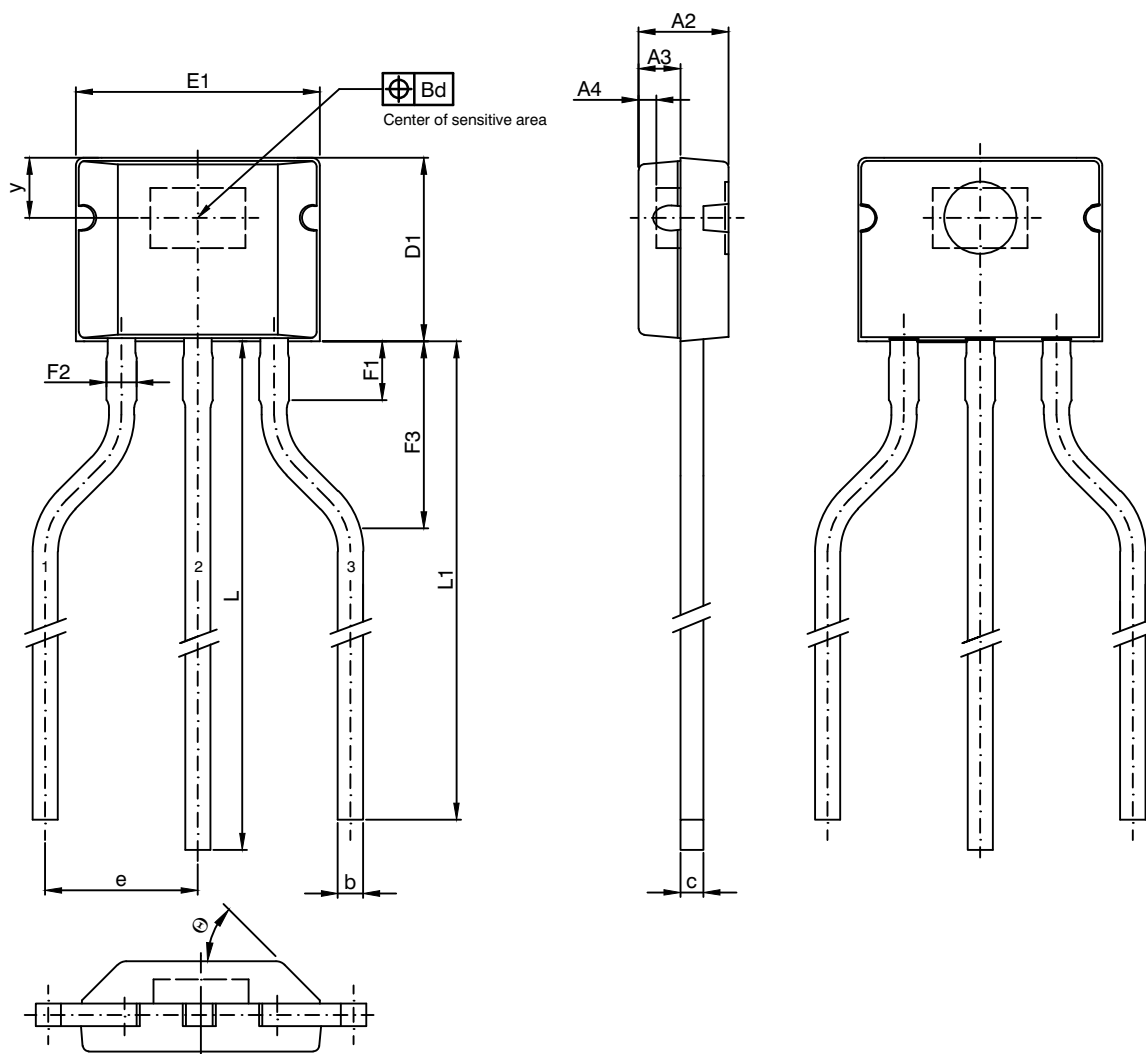

Fig. 4-1:
SOT89B-1: Plastic Small Outline Transistor package, 4 leads
 Ordering code: SF
 Weight approximately 0.034 g



physical dimensions do not include moldflash.

solderability is guaranteed between end of pin and distance F1.

Sn-thickness might be reduced by mechanical handling.

A4, y= these dimensions are different for each sensor type and is specified in the data sheet.

min/max of D1 are specified in the datasheet.

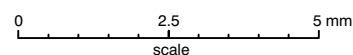

UNIT	A2	A3	b	Bd	c	D1	e	E1	F1	F2	F3	L	L1	θ
mm	1.55 1.45	0.7	0.42	0.2	0.36	3.05	2.54	4.11 4.01	1.2 0.8	0.60 0.42	4.0 2.0	15.5 min	15.0 min	45°

JEDEC STANDARD		ANSI	ISSUE DATE YY-MM-DD	DRAWING-NO.	ZG-NO.
ISSUE	ITEM NO.				
-	-		09-06-09	06616.0001.4	ZG001016_Ver.06

Fig. 4-1:
TO92UA-1: Plastic Transistor Standard UA package, 3 leads, spread
 Weight approximately 0.106 g

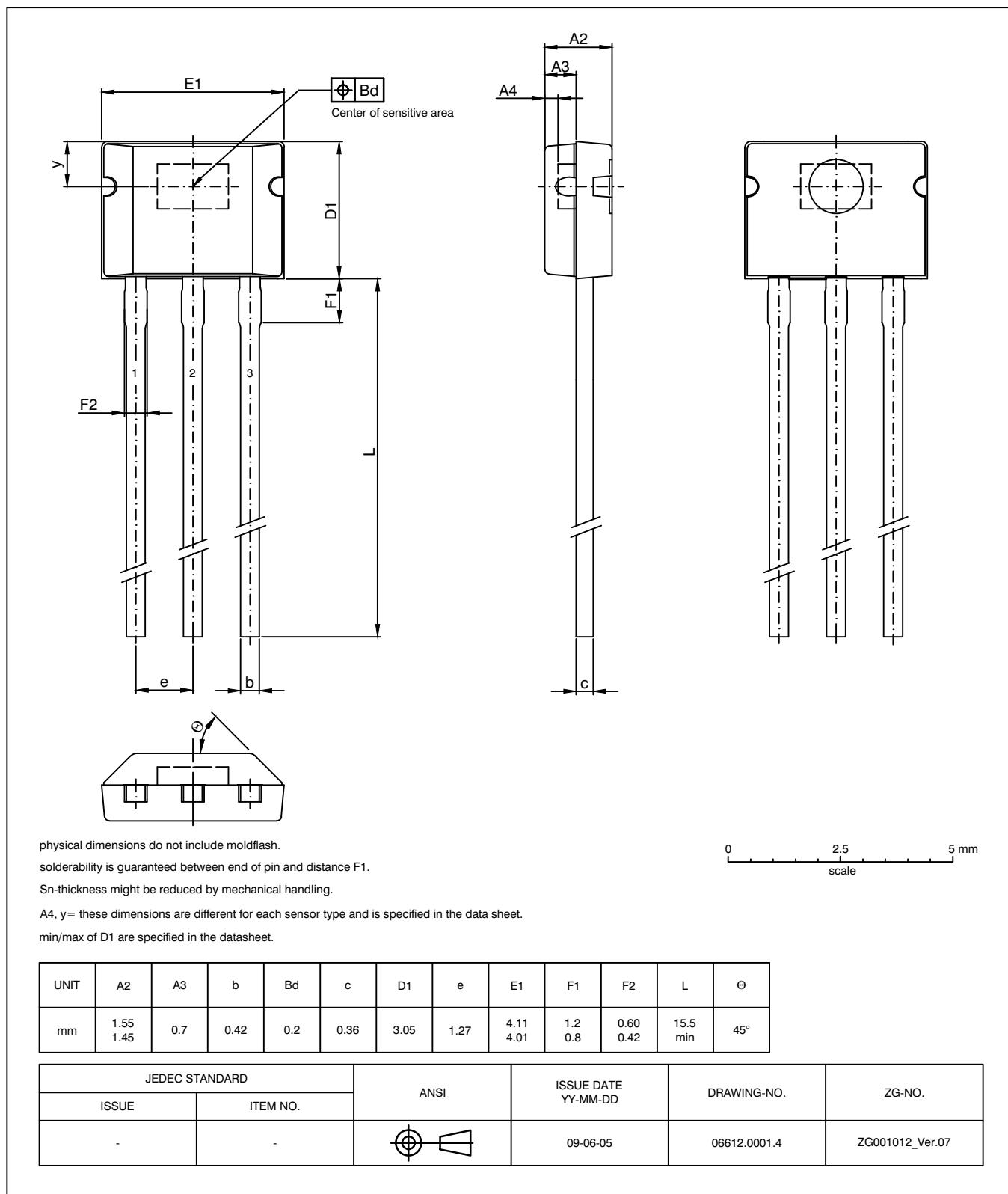

Fig. 4-2:
TO92UA-2: Plastic Transistor Standard UA package, 3 leads, not spread
 Weight approximately 0.106 g

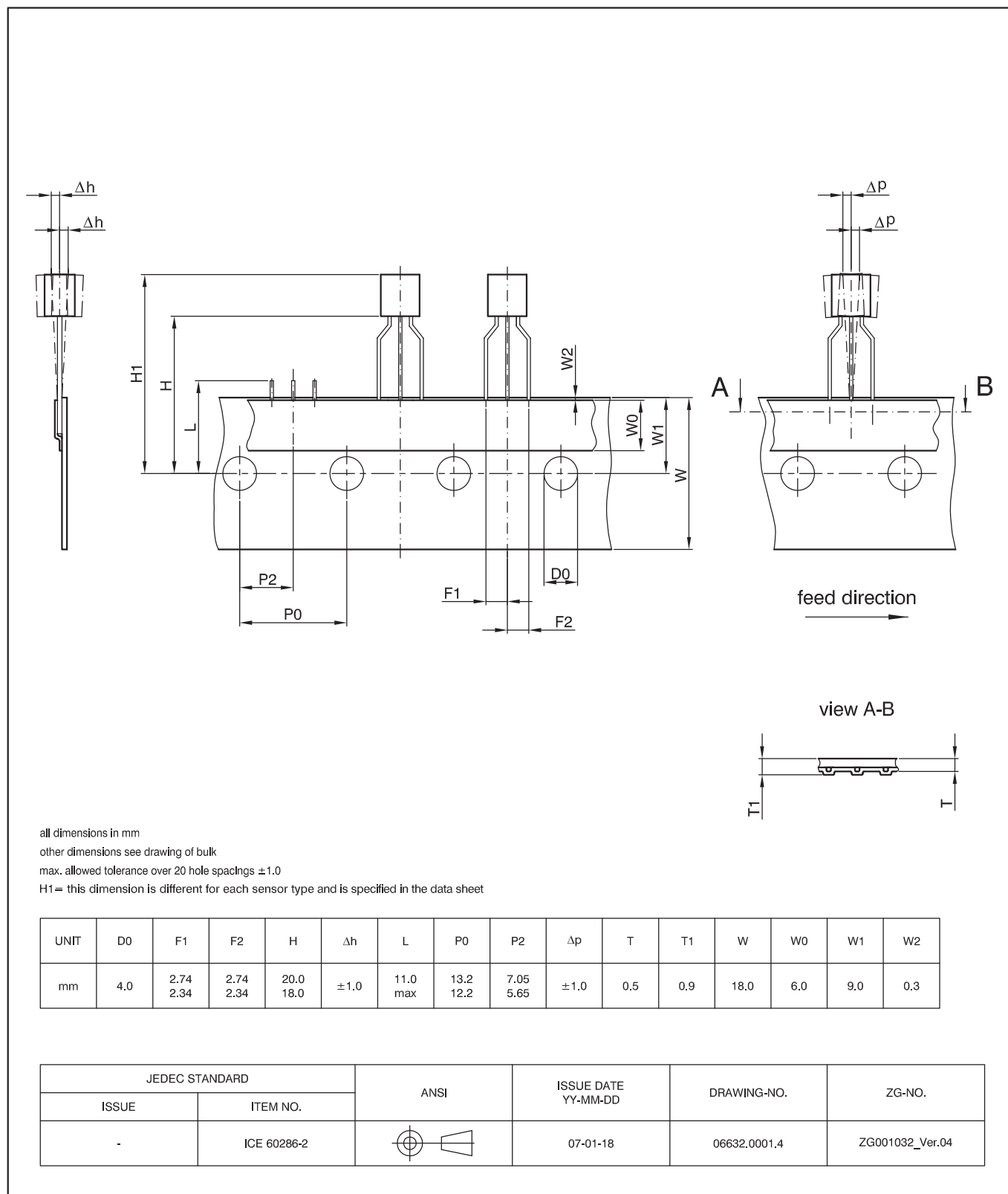

Fig. 4-2:
TO92UA-1: Dimensions ammpack inline, spread

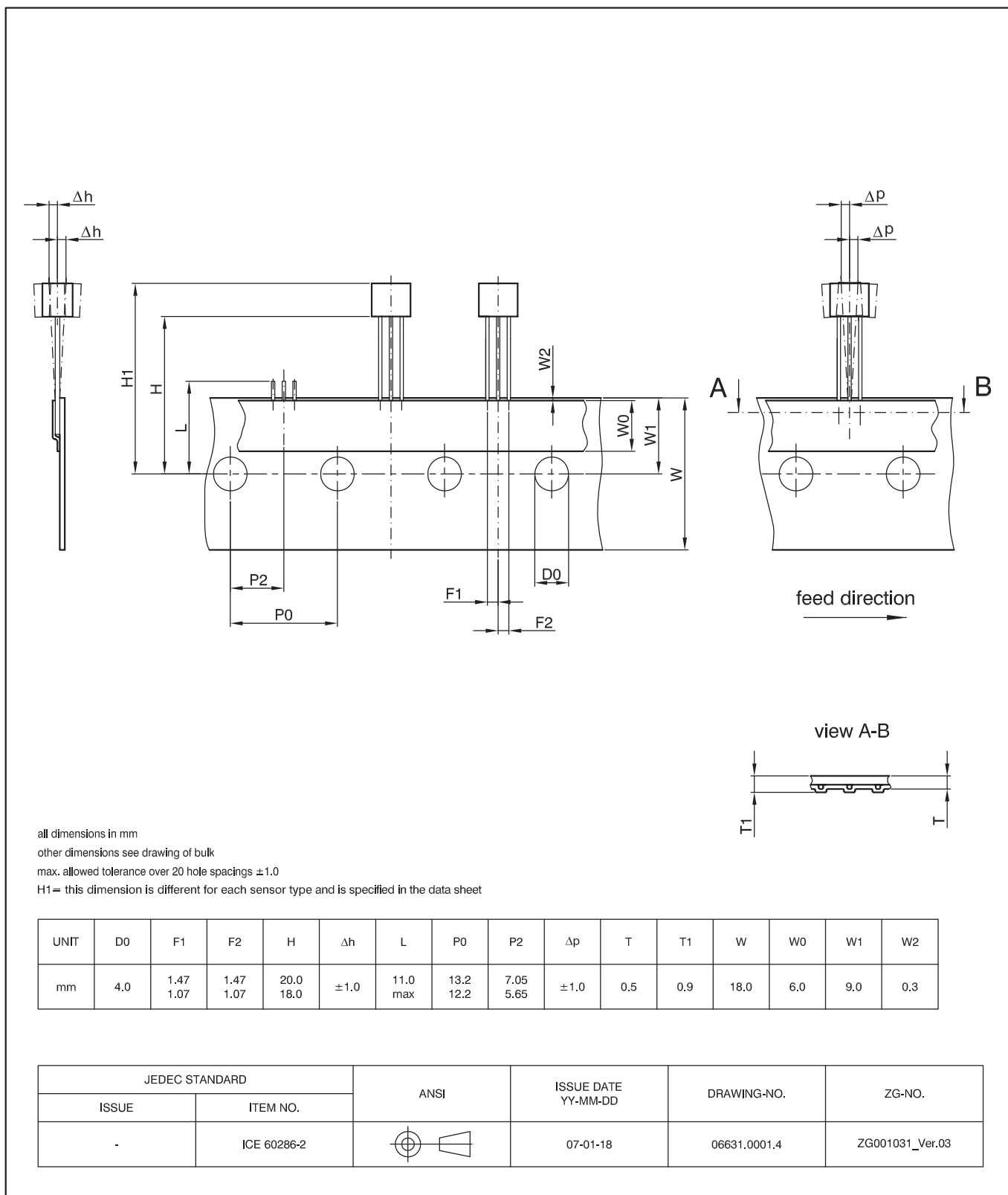

Fig. 4-3:
TO92UA-2: Dimensions ammopack inline, not spread

4.2. Solderability and Welding

Soldering

During soldering reflow processing and manual reworking, a component body temperature of 260 °C should not be exceeded.

Welding

Device terminals should be compatible with laser and resistance welding. Please note that the success of the welding process is subject to different welding parameters which will vary according to the welding technique used. A very close control of the welding parameters is absolutely necessary in order to reach satisfying results. Micronas, therefore, does not give any implied or express warranty as to the ability to weld the component.

4.4. Physical Dimension

4.4.1. Sensitive Area

0.25 mm × 0.12 mm

4.4.2. Position

	SOT89B-1	TO92UA-1/-2
y	0.85 mm nominal	0.9 mm nominal
A4	0.3 mm nominal	0.3 mm nominal
D1	–	3.05 mm ±50 μm
H1	–	min. 21 mm max. 23.1 mm

4.3. Pin Connections and Short Descriptions

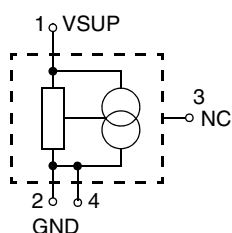

Fig. 4-1: Pin configuration

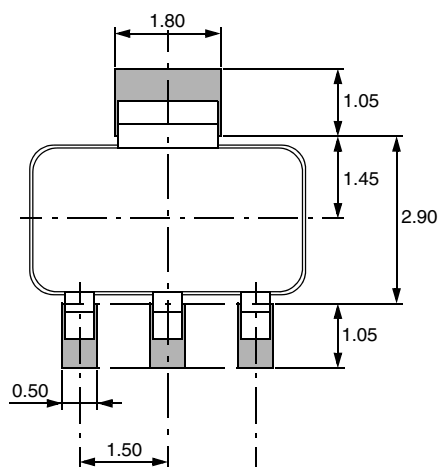

Fig. 4-2: Recommended pad size SOT89B-1
Dimensions in mm

4.5. Absolute Maximum Ratings

Stresses beyond those listed in the “Absolute Maximum Ratings” may cause permanent damage to the device. This is a stress rating only. Functional operation of the device at these conditions is not implied. Exposure to absolute maximum rating conditions for extended periods will affect device reliability.

This device contains circuitry to protect the inputs and outputs against damage due to high static voltages or electric fields; however, it is advised that normal precautions be taken to avoid application of any voltage higher than absolute maximum-rated voltages to this circuit.

All voltages listed are referenced to ground (GND).

Symbol	Parameter	Pin No.	Min.	Max.	Unit
V_{SUP}	Supply Voltage	1	-15 ¹⁾²⁾	28 ²⁾	V
T_J	Junction Temperature Range		-40	170	°C
¹⁾ -18 V with a 100 Ω series resistor at pin 1 (-16 V with a 30 Ω series resistor) ²⁾ as long as T_{Jmax} is not exceeded					

4.5.1. Storage and Shelf Life

The permissible storage time (shelf life) of the sensors is unlimited, provided the sensors are stored at a maximum of 30 °C and a maximum of 85% relative humidity. At these conditions, no Dry Pack is required.

■ Solderability is guaranteed for two years from the date code on the package.

4.6. Recommended Operating Conditions

Functional operation of the device beyond those indicated in the “Recommended Operating Conditions” of this specification is not implied, may result in unpredictable behavior of the device and may reduce reliability and lifetime.

All voltages listed are referenced to ground (GND).

Symbol	Parameter	Pin No.	Min.	Max.	Unit
V_{SUP}	Supply Voltage	1	4	24	V
T_A	Ambient Temperature for Continuous Operations		-40	85 ¹⁾	°C
¹⁾ when using the “K” type and $V_{SUP} \leq 16$ V					

Note: Due to the high power dissipation at high current consumption, there is a difference between the ambient temperature (T_A) and junction temperature. The power dissipation can be reduced by repeatedly switching the supply voltage on and off (pulse mode). Please refer to section 6.4. on page 23 for details.

4.7. Characteristics

at $T_J = -40\text{ }^\circ\text{C}$ to $+140\text{ }^\circ\text{C}$, $V_{SUP} = 4\text{ V}$ to 24 V , $GND = 0\text{ V}$,
 at Recommended Operation Conditions if not otherwise specified in the column "Conditions".
 Typical Characteristics for $T_J = 25\text{ }^\circ\text{C}$ and $V_{SUP} = 12\text{ V}$.

Symbol	Parameter	Pin No.	Min.	Typ.	Max.	Unit	Conditions
I_{SUP}	Low Current Consumption over Temperature Range	1	2	3.3	5	mA	
I_{SUP}	High Current Consumption over Temperature Range	1	12	14.3	17	mA	
V_{SUPZ}	Overshoot Protection at Supply	1	–	28.5	32	V	$I_{SUP} = 25\text{ mA}$, $T_J = 25\text{ }^\circ\text{C}$, $t = 20\text{ ms}$
f_{osc}	Internal Oscillator Chopper Frequency	–	–	145	–	kHz	
$t_{en(O)}$	Enable Time of Output after Setting of V_{SUP}	1	–	30	–	μs	1)
t_r	Output Rise Time	1	–	0.4	1.6	μs	$V_{SUP} = 12\text{ V}$, $R_s = 30\ \Omega$
t_f	Output Fall Time	1	–	0.4	1.6	μs	$V_{SUP} = 12\text{ V}$, $R_s = 30\ \Omega$
R_{thJSB} case SOT89B-1	Thermal Resistance Junction to Substrate Backside	–	–	150	200	K/W	Fiberglass Substrate 30 mm x 10 mm x 1.5 mm, for pad size see Fig. 4–2
R_{thJA} case TO92UA-1, TO92UA-2	Thermal Resistance Junction to Soldering Point	–	–	150	200	K/W	
1) $B > B_{ON} + 2\text{ mT}$ or $B < B_{OFF} - 2\text{ mT}$ for HAL556, $B > B_{OFF} + 2\text{ mT}$ or $B < B_{ON} - 2\text{ mT}$ for HAL566							

4.8. Magnetic Characteristics Overview

at $T_J = -40\text{ °C}$ to $+140\text{ °C}$, $V_{SUP} = 4.0\text{ V}$ to 24 V ,
 Typical Characteristics for $V_{SUP} = 12\text{ V}$

Magnetic flux density values of switching points.

Positive flux density values refer to the magnetic south pole at the branded side of the package.

Sensor	Parameter	On point B_{ON}			Off point B_{OFF}			Hysteresis B_{HYS}			Unit
		Min.	Typ.	Max.	Min.	Typ.	Max.	Min.	Typ.	Max.	
HAL556 unipolar	T_J										
	-40 °C	3.4	6.3	7.7	2.1	4.2	5.9	0.8	2.1	3	mT
	25 °C	3.4	6	7.4	2	3.8	5.7	0.5	1.8	2.8	mT
	100 °C	3.2	5.5	7.2	1.9	3.7	5.7	0.3	1.8	2.8	mT
	140 °C	3	5.2	7.4	1.2	3.6	6	0.2	1.6	3	mT
HAL566 unipolar inverted	T_J										
	-40 °C	2.1	4	5.9	3.4	6	7.7	0.8	2	2.8	mT
	25 °C	2	3.9	5.7	3.4	5.9	7.2	0.5	2	2.7	mT
	100 °C	1.85	3.8	5.7	3.25	5.6	7	0.3	1.8	2.6	mT
	140 °C	1.3	3.6	6	2.6	5.2	7.3	0.2	1.6	3	mT

Note: For detailed descriptions of the individual types, see pages 18 and following.

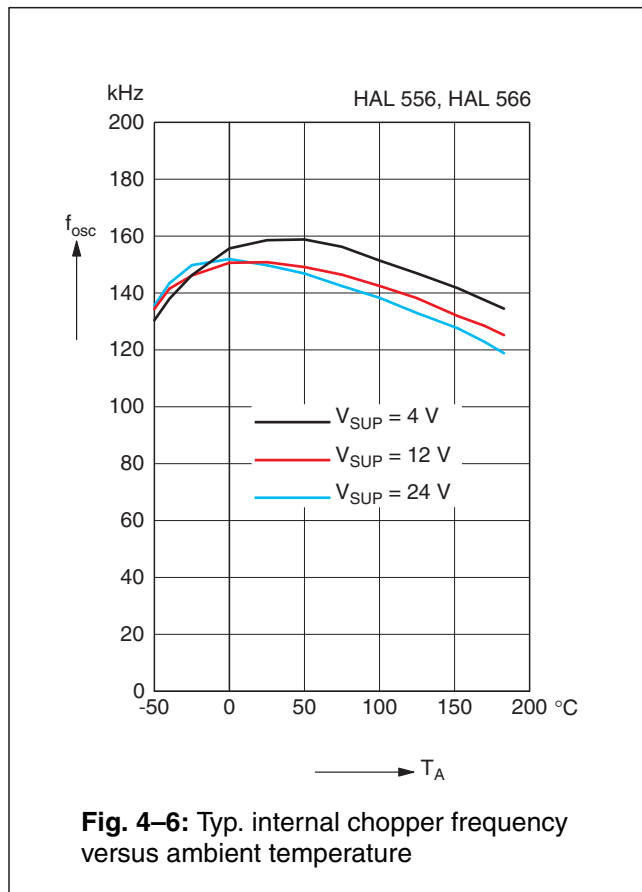
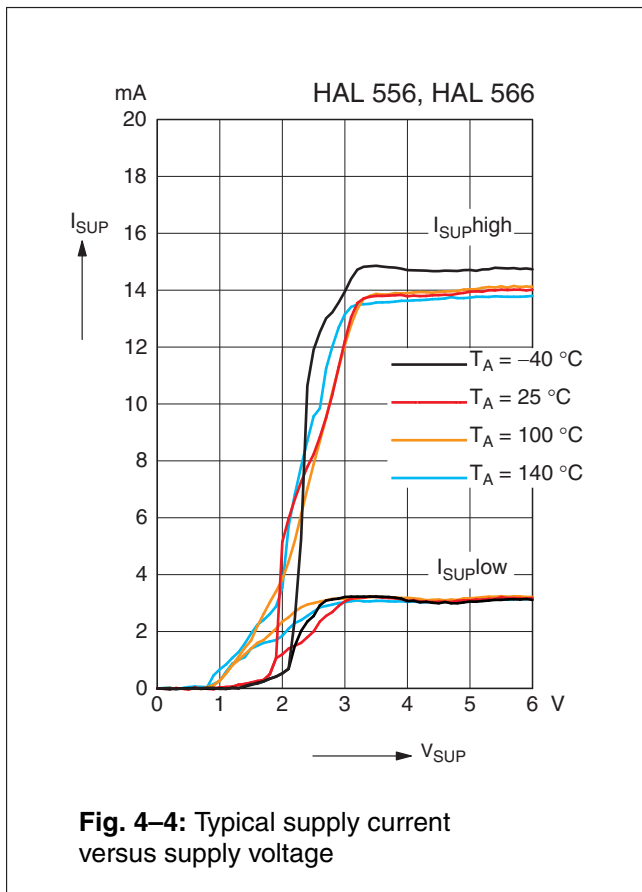
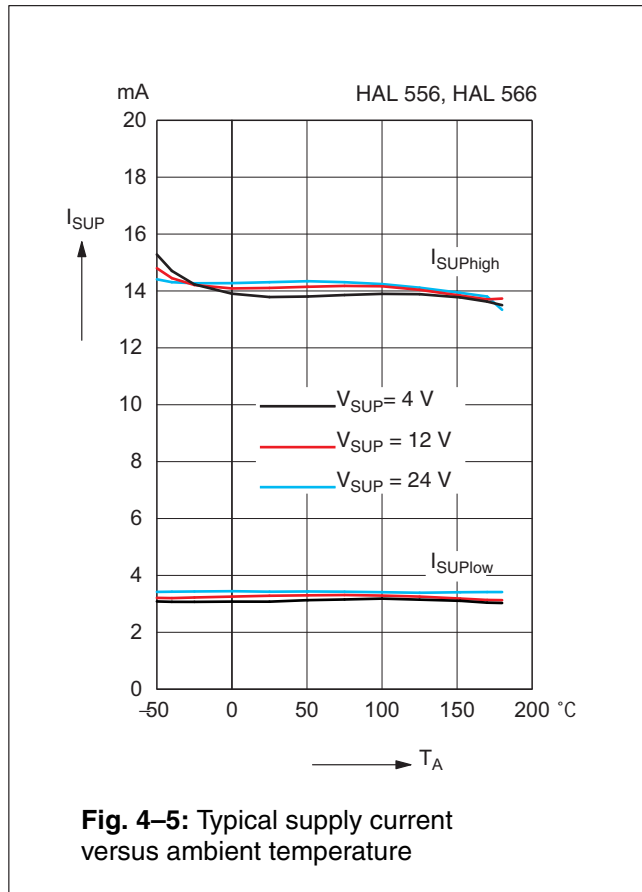
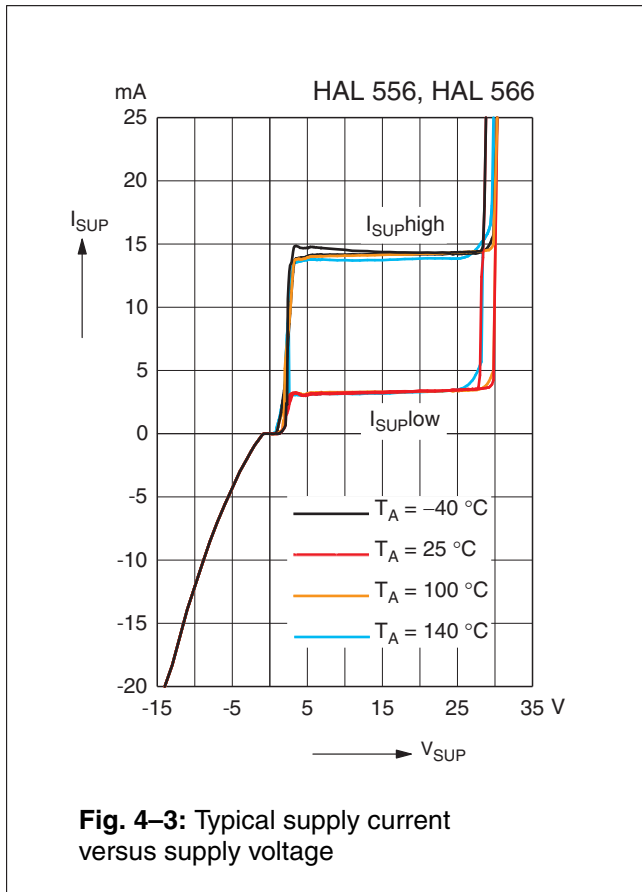

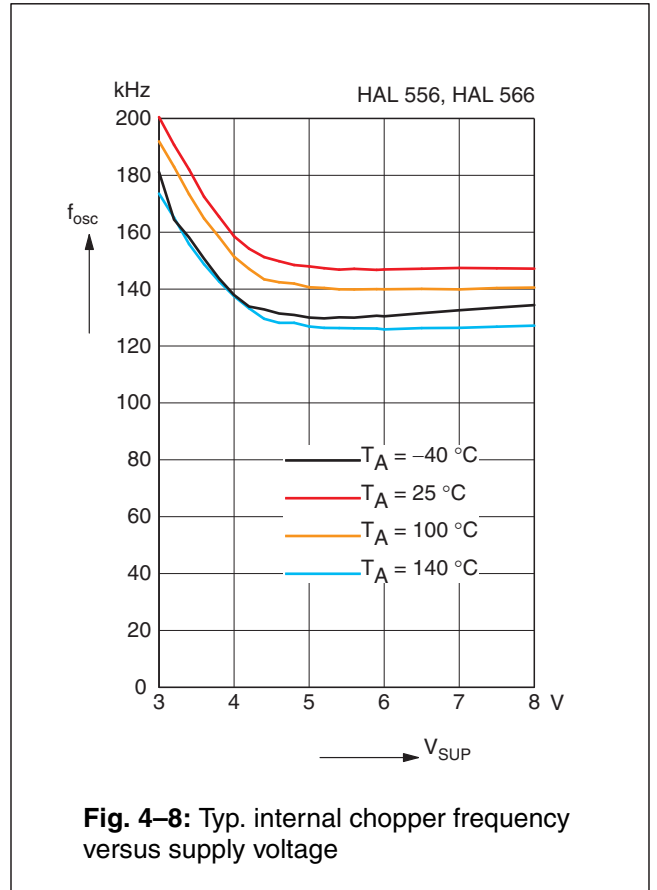
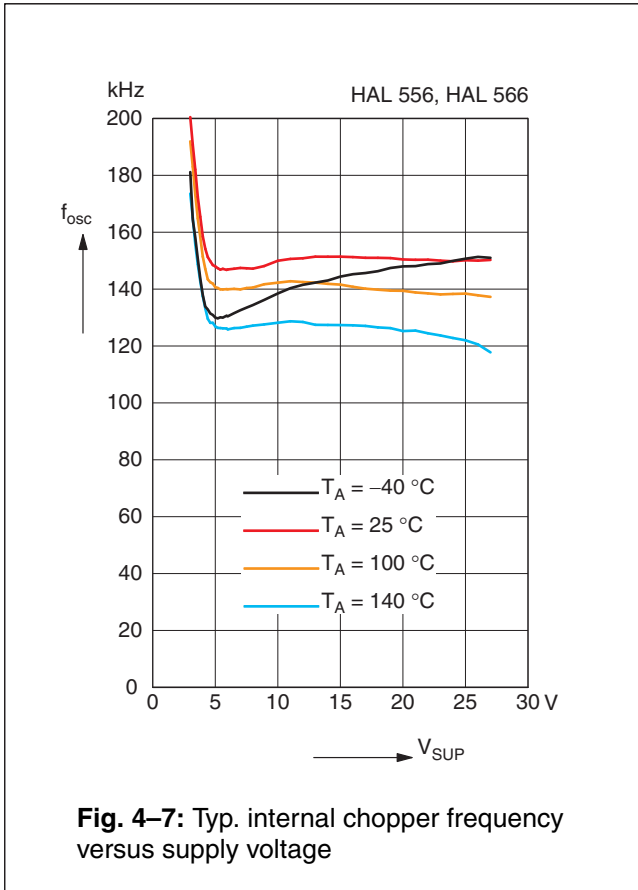

5. Type Description

5.1. HAL556

The HAL556 is a very sensitive unipolar switching sensor (see Fig. 5–1).

The sensor turns to high current consumption with the magnetic south pole on the branded side of the package and turns to low current consumption if the magnetic field is removed. It does not respond to the magnetic north pole on the branded side.

For correct functioning in the application, the sensor requires only the magnetic south pole on the branded side of the package.

The HAL566 is a sensor with the same magnetic characteristics as the HAL556 but with an inverted output characteristic.

Magnetic Features:

- switching type: unipolar
- very high sensitivity
- typical B_{ON} : 6 mT at room temperature
- typical B_{OFF} : 4 mT at room temperature
- operates with static magnetic fields and dynamic magnetic fields up to 10 kHz

Applications

The HAL556 is designed for applications with one magnetic polarity and weak magnetic amplitudes at the sensor position such as:

- applications with large airgap or weak magnets,
- solid state switches,
- contactless solutions to replace micro switches,
- position and end point detection, and
- rotating speed measurement.

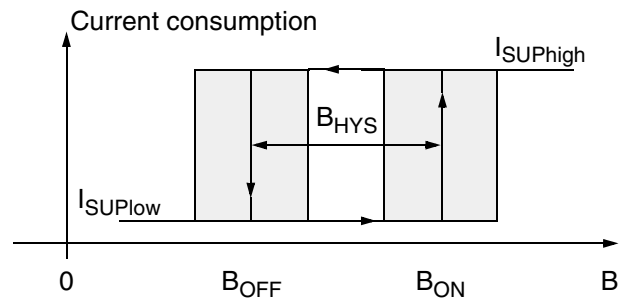

Fig. 5–1: Definition of magnetic switching points for the HAL556

Magnetic Characteristics at $T_J = -40\text{ °C}$ to $+140\text{ °C}$, $V_{SUP} = 4\text{ V}$ to 24 V , Typical Characteristics for $V_{SUP} = 12\text{ V}$

Magnetic flux density values of switching points. Positive flux density values refer to the magnetic south pole at the branded side of the package.

Parameter	On point B_{ON}			Off point B_{OFF}			Hysteresis B_{HYS}			Magnetic Offset			Unit
	Min.	Typ.	Max.	Min.	Typ.	Max.	Min.	Typ.	Max.	Min.	Typ.	Max.	
T_J													
-40 °C	3.4	6.3	7.7	2.1	4.2	5.9	0.8	2.1	3		5.2		mT
25 °C	3.4	6	7.4	2	3.8	5.7	0.5	1.8	2.8	2.7	4.9	6.5	mT
100 °C	3.2	5.5	7.2	1.9	3.7	5.7	0.3	1.8	2.8		4.6		mT
140 °C	3	5.2	7.4	1.2	3.6	6	0.2	1.6	3		4.4		mT

The hysteresis is the difference between the switching points $B_{HYS} = B_{ON} - B_{OFF}$
 The magnetic offset is the mean value of the switching points $B_{OFFSET} = (B_{ON} + B_{OFF}) / 2$

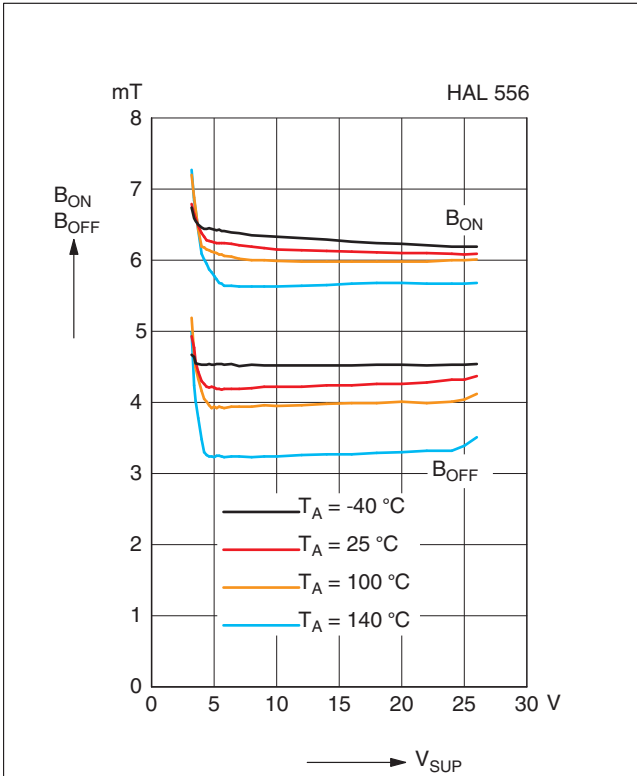

Fig. 5-2: Typ. magnetic switching points versus supply voltage

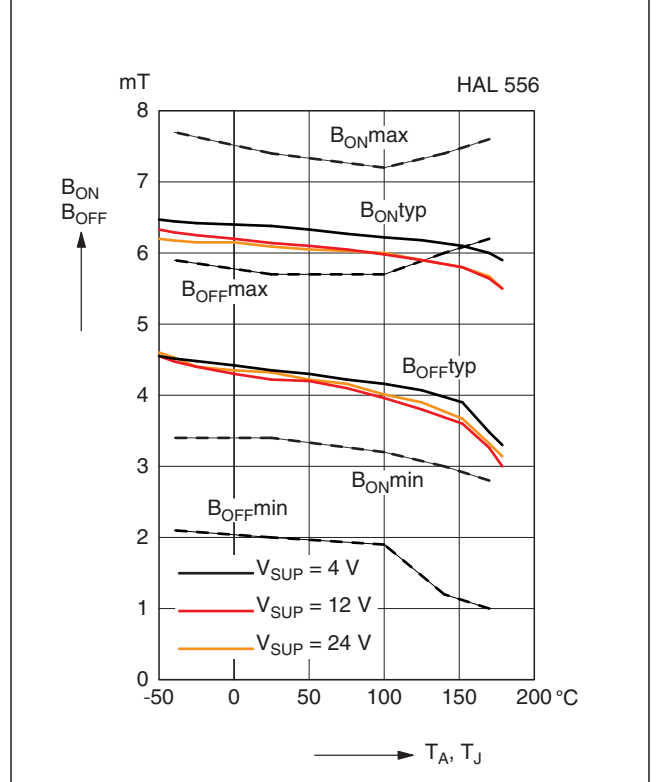

Fig. 5-4: Magnetic switching points versus temperature

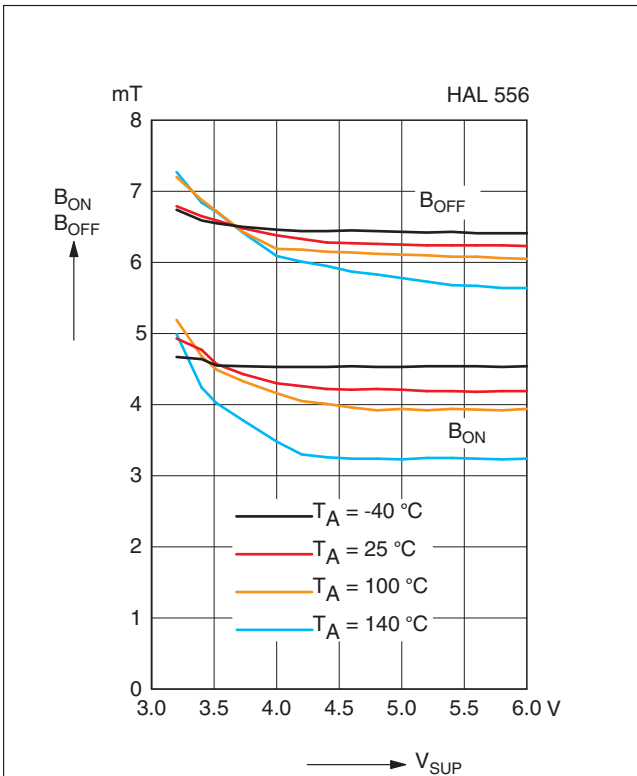

Fig. 5-3: Typ. magnetic switching points versus supply voltage

Note: In the diagram “Magnetic switching points versus temperature”, the curves for B_{ONmin} , B_{ONmax} , B_{OFFmin} , and B_{OFFmax} refer to junction temperature, whereas typical curves refer to ambient temperature.

5.2. HAL566

The HAL566 is a very sensitive unipolar switching sensor with an inverted output (see Fig. 5–5).

The sensor turns to low current consumption with the magnetic south pole on the branded side of the package and turns to high current consumption if the magnetic field is removed. It does not respond to the magnetic north pole on the branded side.

For correct functioning in the application, the sensor requires only the magnetic south pole on the branded side of the package.

The HAL556 is a sensor with the same magnetic characteristics as the HAL566 but with a normal output characteristic.

Magnetic Features:

- switching type: unipolar inverted
- high sensitivity
- typical B_{ON} : 4 mT at room temperature
- typical B_{OFF} : 5.9 mT at room temperature
- operates with static magnetic fields and dynamic magnetic fields up to 10 kHz

Applications

The HAL566 is designed for applications with one magnetic polarity and weak magnetic amplitudes at the sensor position where an inverted output signal is required such as:

- applications with large airgap or weak magnets,
- solid state switches,
- contactless solutions to replace micro switches,
- position and end point detection, and
- rotating speed measurement.

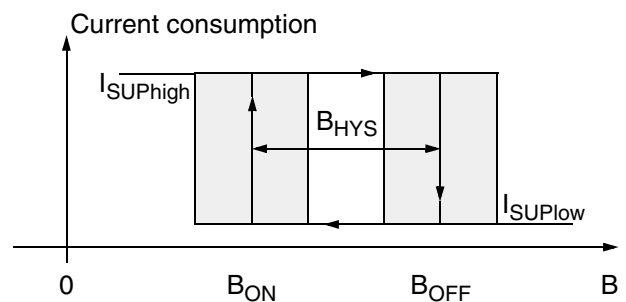

Fig. 5–5: Definition of magnetic switching points for the HAL566

Magnetic Characteristics at $T_J = -40\text{ °C}$ to $+140\text{ °C}$, $V_{SUP} = 4\text{ V}$ to 24 V , Typical Characteristics for $V_{SUP} = 12\text{ V}$

Magnetic flux density values of switching points.

Positive flux density values refer to the magnetic south pole at the branded side of the package.

Parameter T_J	On point B_{ON}			Off point B_{OFF}			Hysteresis B_{HYS}			Magnetic Offset			Unit
	Min.	Typ.	Max.	Min.	Typ.	Max.	Min.	Typ.	Max.	Min.	Typ.	Max.	
-40 °C	2.1	4	5.9	3.4	6	7.7	0.8	2	2.8	–	5	–	mT
25 °C	2	3.9	5.7	3.4	5.9	7.2	0.5	2	2.7	3	4.9	6.2	mT
100 °C	1.85	3.8	5.7	3.25	5.6	7	0.3	1.8	2.6	–	4.7	–	mT
140 °C	1.3	3.6	6	2.6	5.2	7.3	0.2	1.6	3	–	4.4	–	mT

The hysteresis is the difference between the switching points $B_{HYS} = B_{ON} - B_{OFF}$
 The magnetic offset is the mean value of the switching points $B_{OFFSET} = (B_{ON} + B_{OFF}) / 2$

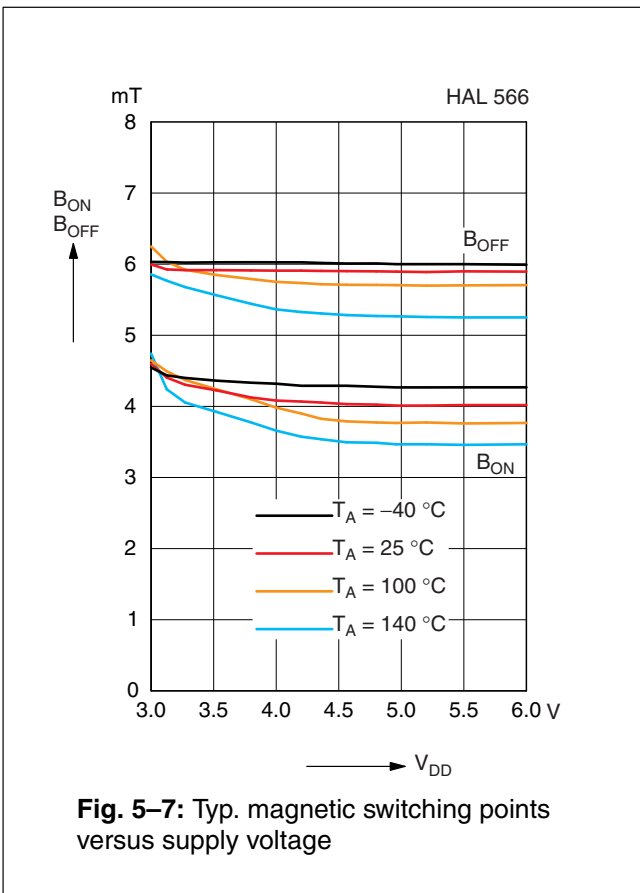
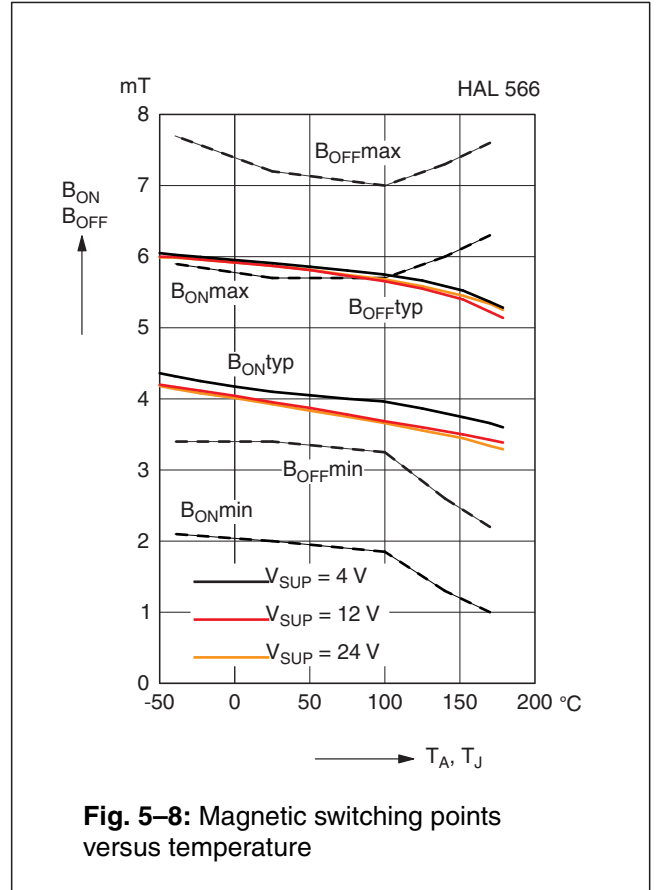
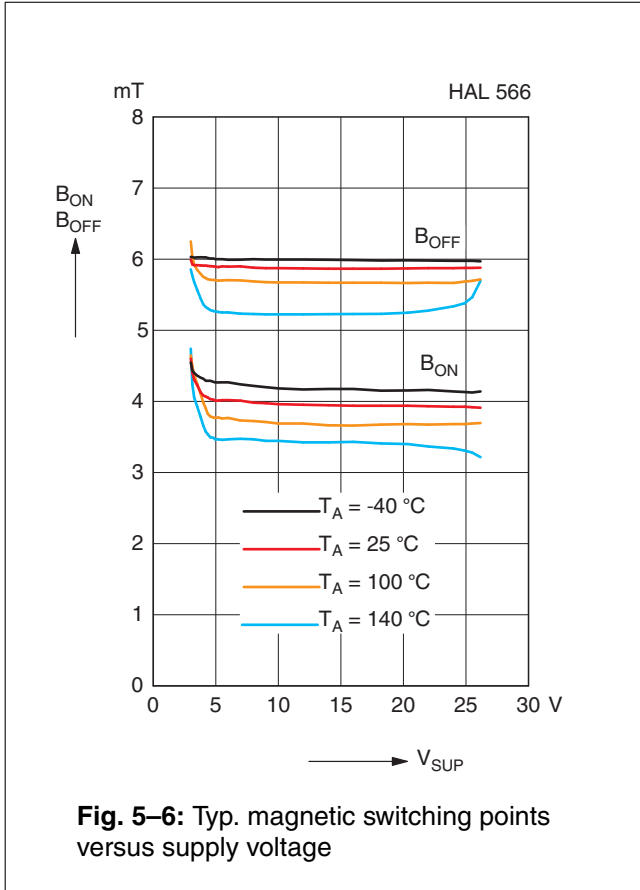

Note: In the diagram “Magnetic switching points versus temperature”, the curves for B_{ONmin} , B_{ONmax} , B_{OFFmin} , and B_{OFFmax} refer to junction temperature, whereas typical curves refer to ambient temperature.

6. Application Notes

6.1. Application Circuit

Figure 6–1 shows a simple application with a two-wire sensor. The current consumption can be detected by measuring the voltage over R_L . For correct functioning of the sensor, the voltage between pin 1 and 2 (V_{SUP}) must be a minimum of 4 V. With the maximum current consumption of 17 mA, the maximum R_L can be calculated as:

$$R_{Lmax} = \frac{V_{SUPmin} - 4V}{17mA}$$

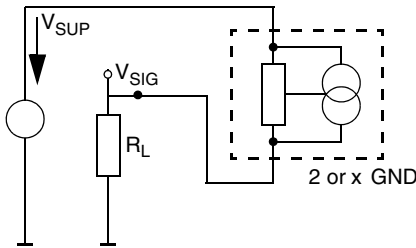

Fig. 6–1: Application circuit 1

For applications with disturbances on the supply line or radiated disturbances, a series resistor R_V (ranging from 10 Ω to 30 Ω) and a capacitor both placed close to the sensor are recommended (see Fig. 6–2). In this case, the maximum R_L can be calculated as:

$$R_{Lmax} = \frac{V_{SUPmin} - 4V}{17mA} - R_V$$

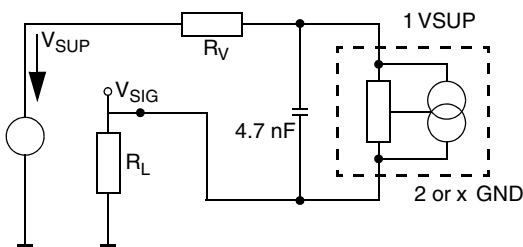

Fig. 6–2: Application circuit 2

6.2. Extended Operating Conditions

All sensors fulfill the electrical and magnetic characteristics when operated within the Recommended Operating Conditions (see page 13).

Typically, the sensors operate with supply voltages above 3 V. However, below 4 V, the current consumption and the magnetic characteristics may be outside the specification.

Note: The functionality of the sensor below 4 V is not tested on a regular base. For special test conditions, please contact Micronas.

6.3. Start-up Behavior

Due to the active offset compensation, the sensors have an initialization time (enable time $t_{en(O)}$) after applying the supply voltage. The parameter $t_{en(O)}$ is specified in the Electrical Characteristics (see page 14). During the initialization time, the current consumption is not defined and can toggle between low and high.

HAL556:

After $t_{en(O)}$, the current consumption will be high if the applied magnetic field B is above B_{ON} . The current consumption will be low if B is below B_{OFF} .

HAL566:

In case of sensors with an inverted switching behavior, the current consumption will be low if $B > B_{OFF}$ and high if $B < B_{ON}$.

Note: For magnetic fields between B_{OFF} and B_{ON} , the current consumption of the HAL sensor will be either low or high after applying V_{SUP} . In order to achieve a defined current consumption, the applied magnetic field must be above B_{ON} , respectively, below B_{OFF} .

6.4. Ambient Temperature

Due to internal power dissipation, the temperature on the silicon chip (junction temperature T_J) is higher than the temperature outside the package (ambient temperature T_A).

$$T_J = T_A + \Delta T$$

Under static conditions and continuous operation, the following equation applies:

$$\Delta T = I_{SUP} \times V_{SUP} \times R_{TH}$$

For all sensors, the junction temperature range T_J is specified. The maximum ambient temperature T_{Amax} can be calculated as:

$$T_{Amax} = T_{Jmax} - \Delta T$$

For typical values, use the typical parameters. For worst case calculation, use the max. parameters for I_{SUP} and R_{th} , and the max. value for V_{SUP} from the application.

Due to the range of $I_{SUPhigh}$, self-heating can be critical. The junction temperature can be reduced with pulsed supply voltage. For supply times (t_{on}) ranging from 30 μs to 1 ms, the following equation can be used:

$$\Delta T = I_{SUP} \times V_{SUP} \times R_{th} \times \frac{t_{on}}{t_{off} + t_{on}}$$

6.5. EMC and ESD

For applications with disturbances on the supply line or radiated disturbances, a series resistor and a capacitor are recommended (see Fig. 6–3). The series resistor and the capacitor should be placed as closely as possible to the HAL sensor.

Applications with this arrangement passed the EMC tests according to the product standard ISO 7637.

Please contact Micronas for the detailed investigation reports with the EMC and ESD results.

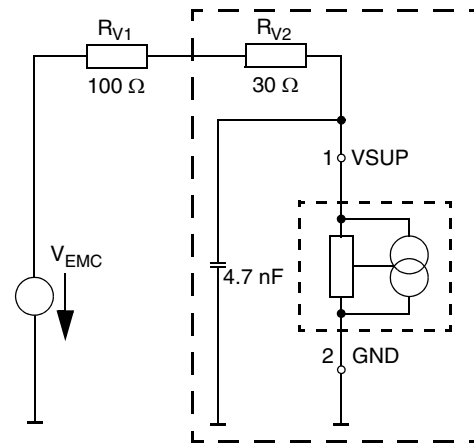

Fig. 6–3: Recommended EMC test circuit

7. Data Sheet History

1. Data sheet: "HAL54x Hall-Effect Sensor Family", Nov. 27, 2002, 6251-605-1DS. First release of the data sheet.
2. Data sheet: "HAL556, HAL560, HAL566, Two-Wire Hall-Effect Sensor Family, Aug. 3, 2000, 6251-425-2DS. Second release of the data sheet. Major changes:
 - magnetic characteristics for HAL556 and HAL560 changed. Please refer to pages 12 and 14 for details.
 - new temperature ranges "K" and "A" added
 - temperature range "C" removed
 - outline dimensions for SOT-89B: reduced tolerances
 - SMD package SOT-89A removed
3. Data sheet: "HAL556, HAL560, HAL566, Two-Wire Hall-Effect Sensor Family, Jan. 28, 2003, 6251-425-3DS. Third release of the data sheet. Major changes:
 - temperature range "A" removed
 - outline dimensions for TO-92UA changed
4. Data sheet: "HAL556, HAL560, HAL566, Two-Wire Hall-Effect Sensor Family, May 14, 2004, 6251-425-4DS (DSH000026_001EN). Fourth release of the data sheet. Major changes:
 - new package diagrams for SOT89B-1 and TO92UA-1
 - package diagram for TO92UA-2 added
 - ammpack diagrams for TO92UA-1/-2 added
5. Data Sheet: "HAL556, HAL566 Two-Wire Hall-Effect Sensor Family", Dec. 19, 2008, DSH000026_002EN. Fifth release of the data sheet. Major changes:
 - Section 4.2. on page 12 "Solderability and Welding updated
 - all package diagrams updated
 - recommended footprint SOT89B-1 added
 - HAL 560 removed.
6. Data Sheet: "HAL556, HAL566 Two-Wire Hall-Effect Sensors", Feb. 12, 2009, DSH000026_006EN. Sixth release of the data sheet. Minor changes:
 - Section 4.4.2. "Position" updated (parameter A4 for SOT89B-1 was added).
7. Data Sheet: "HAL556, HAL566 Two-Wire Hall-Effect Sensors", Aug. 11, 2010, DSH000026_004EN. Seventh release of the data sheet. Major changes:
 - Package outlines updated
 - HAL 560 added.
8. Data Sheet: "HAL556, HAL 560, HAL566 Two-Wire Hall-Effect Sensor Family", Aug. 29, 2011, DSH000026_005EN. Eighth release of the data sheet. Major changes:
 - Position of sensitive area for SOT89B-1 and TO92UA-1/-2 package corrected
9. Data Sheet: "HAL556, HAL566 Two-Wire Hall-Effect Sensors", Sept. 18, 2014, DSH000026_006EN. Ninth release of the data sheet. Major changes:
 - HAL 560 removed
 - TO92UA package drawings updated