





IGNITION TRANSFORMERS

Spark-Line - 233mH - 375mH



-  Compact Design
-  Available up to 23kV
-  Ambient Temperature 70°C
-  Weight: 0.018kg
-  Packaging unit: 55 pieces (tray)

Part Number	Primary Resistance (±10%) (Pin 1-2)	Secondary Resistance (±10%) (Pin 3-4)	Primary Inductance (±15%) (Pin 1-2)	Secondary Inductance (±15%) (Pin 3-4)	Winding Ratio	Secondary Voltage @ load 30pF	Ambient Temperature	No-Load Operation (MAX)
125-0028.0	26mΩ	520Ω	6μH	240mH	1:200	>22kV	70°C	30s
125-0031.0	26mΩ	786Ω	6μH	375mH	1:256	>20kV	70°C	30s
125-0033.0	59mΩ	822Ω	12μH	340mH	1:175	>23kV	70°C	30s
125-0039.0	59mΩ	590Ω	12μH	233mH	1:150	>23kV	70°C	30s

Mechanical

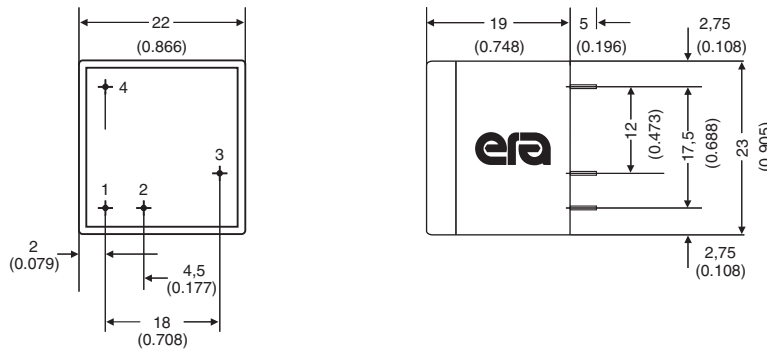



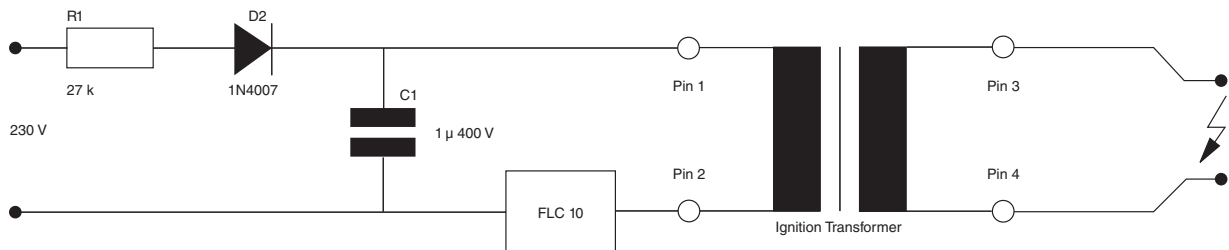

Schematic



IGNITION TRANSFORMERS

Spark-Line - Secondary External (1x)



-  Compact Design
-  Available up to 22kV
-  Ambient Temperature 70°C
-  Weight: 0.019kg
-  Packaging unit: 45 pieces (tray)

Part Number	Primary Resistance (±10%) (Pin 1-2)	Secondary Resistance (±10%) (Pin 3-6)	Primary Inductance (±15%) (Pin 1-2)	Secondary Inductance (±15%) (Pin 3-6)	Winding Ratio	Secondary Voltage @ load 30pF	Ambient Temperature	No-Load Operation (MAX)
125-0032.0	26mΩ	520Ω	6μH	240mH	1:200	>22kV	70°C	30s

Mechanical

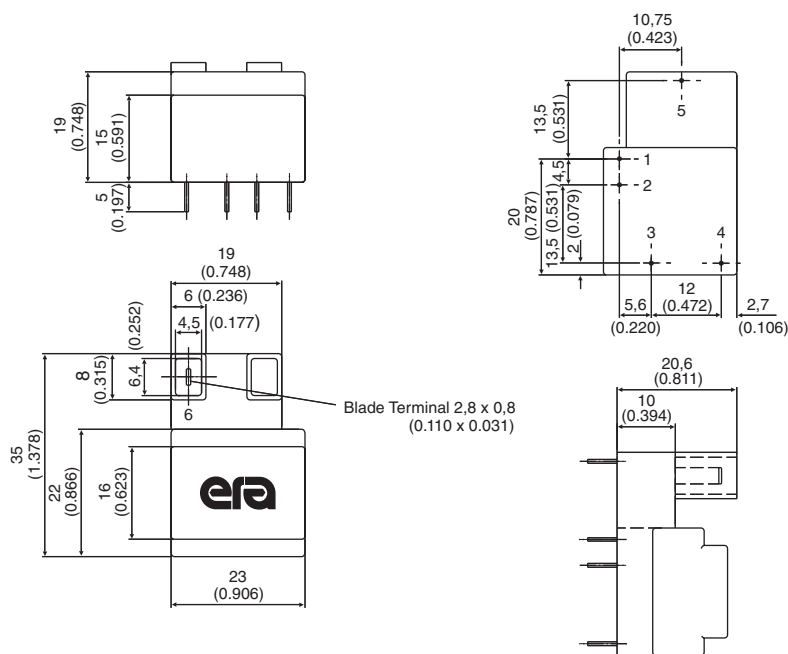

Schematic

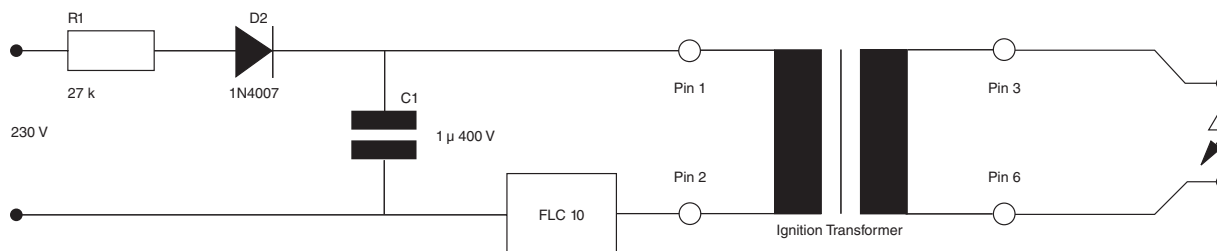

IGNITION TRANSFORMERS

Spark-Line - Secondary External (2x)



- Compact Design
- Available up to 23kV
- Ambient Temperature 70°C
- Weight: 0.018kg
- Packaging unit: 45 pieces (tray)

Part Number	Primary Resistance (±10%) (Pin 1-2)	Secondary Resistance (±10%) (Pin 6-7)	Primary Inductance (±15%) (Pin 1-2)	Secondary Inductance (±15%) (Pin 6-7)	Winding Ratio	Secondary Voltage @ load 30pF	Ambient Temperature	No-Load Operation (MAX)
125-0035.0	26mΩ	520Ω	6μH	240mH	1:200	>22kV	70°C	30s
125-0049.0	59mΩ	822Ω	12μH	340mH	1:175	>23kV	70°C	30s

Mechanical

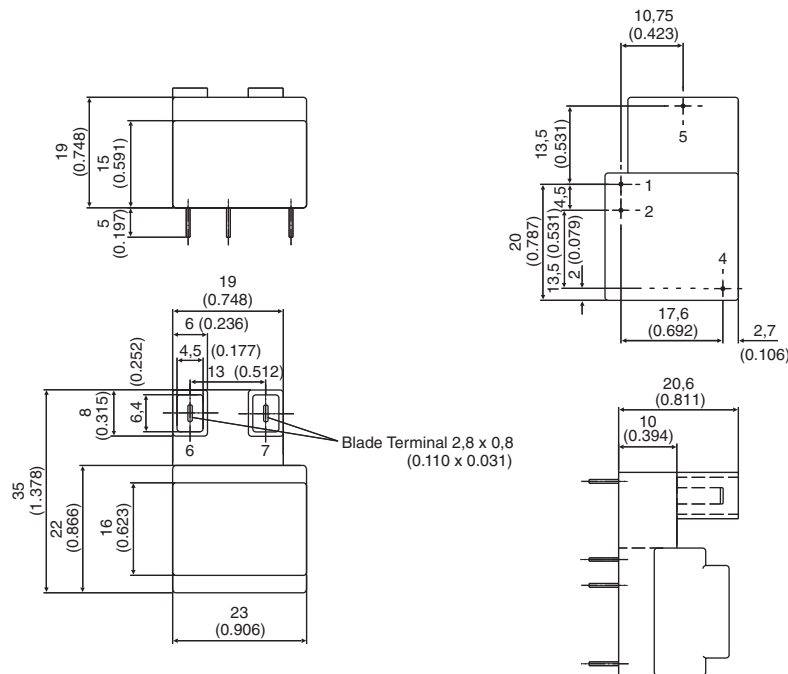

Schematic

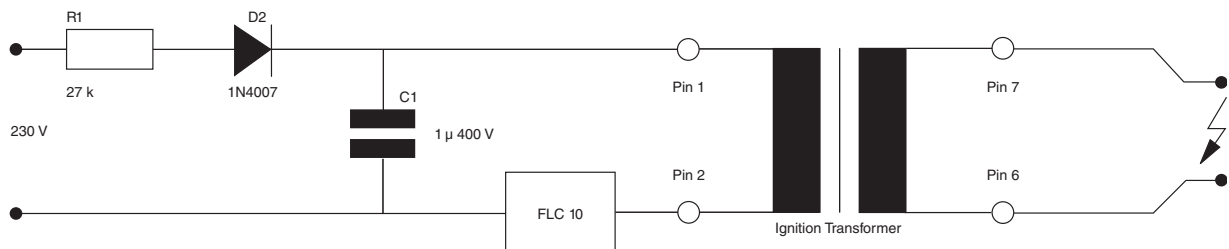

LAMINATED TRANSFORMERS

Low Frequency, Open-Style Laminated, Low Profile, Plug-In Series

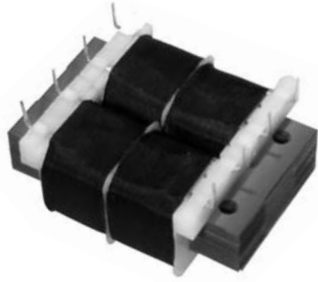

AGENCY APPROVALS

- UL, 506, File E73539
- UL 1446, File E80130
- CSA 22.2#66, File LR68051-2

- ⊕ Semi-toroidal construction reduces EMI
- ⊕ Low profile - Ideal for low height PC board applications
- ⊕ 1500V_{RMS} HIPOT
- ⊕ Vacuum impregnated - withstands board washing systems and reduces audible noise
- ⊕ Baked resin provides environmentally-resistant finish
- ⊕ Sizes 2, 6 and 12 are available as encapsulated, hermetically sealed (request drawings)

Mechanical

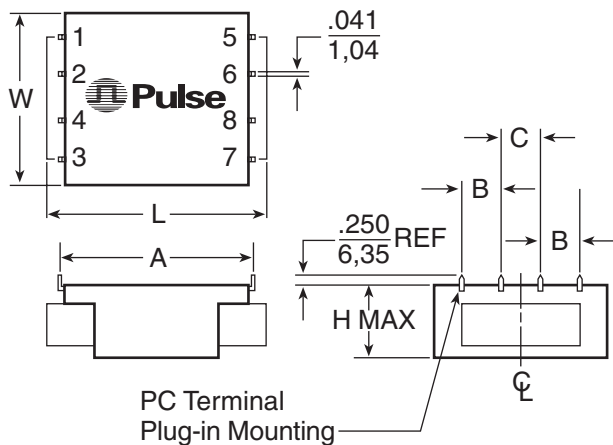

PC Terminal Plug-in Mounting

Schematic

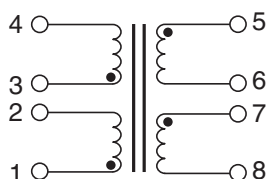

Part Number	Size	Secondary RMS Rating	
		Series	Parallel
LP10-250B23	2	10V C.T. @ 250mA	5V @ 500mA
LP10-600B1	6	10V C.T. @ 600mA	5V @ 1.20A
LP10-1200B2	12	10V C.T. @ 1.20A	5V @ 2.40A
LP12-200B24	2	12.6V C.T. @ 200mA	6.3V @ 400mA
LP12-450B3	6	12.6V C.T. @ 450mA	6.3V @ 900mA
LP12-900B4	12	12.6V C.T. @ 900mA	6.3V @ 1.80A
LP16-150B25	2	16V C.T. @ 150mA	8V @ 300mA
LP16-350B5	6	16V C.T. @ 350mA	8V @ 700mA
LP16-700B6	12	16V C.T. @ 700mA	8V @ 1.40A
LP18-135B105	2	18V C.T. @ 135mA	9V @ 270mA
LP18-325B106	6	18V C.T. @ 325mA	9V @ 650mA
LP18-650B107	12	18V C.T. @ 650mA	9V @ 1.30A
LP20-125B26	2	20V C.T. @ 125mA	10V @ 250mA
LP20-300B7	6	20V C.T. @ 300mA	10V @ 600mA
LP20-600B8	12	20V C.T. @ 600mA	10V @ 1.20A
LP24-100B27	2	24V C.T. @ 100mA	12V @ 200mA
LP24-250B9	6	24V C.T. @ 250mA	12V @ 500mA
LP24-500B10	12	24V C.T. @ 500mA	12V @ 1.00A
LP28-90B115	2	28V C.T. @ 90mA	14V @ 180mA
LP28-215B116	6	28V C.T. @ 215mA	14V @ 430mA
LP28-430B117	12	28V C.T. @ 430mA	14V @ 860mA
LP30-85B125	2	30V C.T. @ 85mA	15V @ 170mA
LP30-200B126	6	30V C.T. @ 200mA	15V @ 400mA
LP30-400B127	12	30V C.T. @ 400mA	15V @ 800mA
LP34-75B28	2	34V C.T. @ 75mA	17V @ 150mA
LP34-170B11	6	34V C.T. @ 170mA	17V @ 340mA
LP34-340B12	12	34V C.T. @ 340mA	17V @ 680mA
LP40-60B29	2	40V C.T. @ 60mA	20V @ 120mA
LP40-150B13	6	40V C.T. @ 150mA	20V @ 300mA
LP40-300B14	12	40V C.T. @ 300mA	20V @ 600mA
LP56-45B30	2	56V C.T. @ 45mA	28V @ 90mA
LP56-100B15	6	56V C.T. @ 100mA	28V @ 200mA
LP56-200B16	12	56V C.T. @ 200mA	28V @ 400mA
LP88-28B31	2	88V C.T. @ 28mA	44V @ 56mA
LP88-65B17	6	88V C.T. @ 65mA	44V @ 130mA
LP88-130B18	12	88V C.T. @ 130mA	44V @ 260mA
LP120-20B32	2	120V C.T. @ 20mA	60V @ 40mA
LP120-50B19	6	120V C.T. @ 50mA	60V @ 100mA
LP120-100B20	12	120V C.T. @ 100mA	60V @ 200mA
LP230-10B33	2	230V C.T. @ 10mA	115V @ 20mA
LP230-25B21	6	230V C.T. @ 25mA	115V @ 50mA
LP230-50B22	12	230V C.T. @ 50mA	115V @ 100mA

Dimensions (inches)

Size	L	W	H	A	B	C	Wt. (oz.)	Reg. (% TYPE)	Trise (°C TYPE)
2	1.875	1.562	.650	1.600	.375	.375	5	20	25
6	1.875	1.562	.850	1.600	.375	.375	7	18	30
12	2.500	2.000	1.065	2.000	.500	.500	11	15	30